



## **AGENDA REGULAR BOARD MEETING**

**FAIR OAKS WATER DISTRICT OFFICE  
10326 FAIR OAKS BLVD, FAIR OAKS  
MAY 20, 2024  
6:30 PM**

*The Board of Directors of the Fair Oaks Water District holds its Regular Board Meetings on the third Monday of each month at 6:30 p.m. The meetings are held at the District Offices located at 10326 Fair Oaks Blvd., Fair Oaks, CA 95628. The Board may discuss any item on the agenda and may act on any of those items.*

*The Board of Directors welcomes public participation in its meetings. Public comments relating to matters within jurisdiction of the District, and not included on the posted agenda, may be addressed under "public comment," both at the beginning and at the end of the meeting, subject to reasonable time limitations for each speaker. Please note that State law prevents the Board from discussing or acting on items not listed on the agenda. Public comments relating to matters listed on the agenda may be provided at the time when that agenda item is heard.*

*Agenda items are numbered for identification purposes only and will not necessarily be considered in the indicated order. Items appearing on the Consent Calendar are considered routine and may be acted upon by the Board by one motion, without discussion; however, any item may be considered separately at the request of any Board member or any member of the public.*

*In compliance with the American with Disabilities Act, if you have a disability and need a disability-related modification or accommodation to participate in this meeting, please contact the Human Resource Administrator at (916) 967-5723. Requests must be made as early as possible, and at least one full business day before the start of the meeting.*

### **I. CALL TO ORDER**

### **II. PUBLIC COMMENT**

### **III. CONSENT CALENDAR**

1. Approval of Minutes
  - a. Regular Board Meeting of April 15, 2024
2. Accept and File Treasurer's Report for the month of April 2024
3. File Investment Report for the month of March 2024

4. Accept and File Financial Expense Report for the month of April 2024
5. Approval of Warrants
6. Approval of Cal-Card Statements for the month of April 2024
7. Approval of Board Expense Report for the month of April 2024

#### **IV. PRESENTATIONS AND CORRESPONDENCE**

1. None

#### **V. DISCUSSION AND ACTION ITEMS: OLD BUSINESS**

1. Discussion and possible action on the selection of a consultant to provide professional design services for the Northridge Well Project
2. Discussion and possible action on the New York Water Main Replacement Project

#### **VI. DISCUSSION AND ACTION ITEMS: NEW BUSINESS**

1. Discussion on FOWD Water Supply for the month of April 2024
2. Discussion and possible action on moving the June 17, 2024 and July 15, 2024 FOWD Regular Board Meeting dates
3. Discussion and possible action on an updated FOWD Policy No. 1010: “Conflict of Interest”
4. Update and discussion on the Transmission Pipeline Main Break at Pershing Avenue and Chestnut Avenue
5. Update and discussion on the 2023 Consumer Confidence Report
6. Update and discussion on the candidate statement costs for the November 2024 General Election
7. Update and discussion on State proposed “Water Budgets” for FOWD customers
8. Discussion and possible action on additional funding for 2024 expenses

#### **VII. UPCOMING EVENTS**

1. May 20, 2024 / SJWD Public Information Committee Meeting / SJWD Office
2. May 22, 2024 / SJWD Board Meeting / SJWD Office
3. June 13, 2024 / SGA Board Meeting / Sacramento
4. June 23-26 / CSDA GM Leadership Summit / Anaheim

#### **VIII. REPRESENTATIVE REPORTS**

1. Sacramento Groundwater Authority (SGA)
2. Regional Water Authority (RWA)
3. Sacramento Water Forum
4. Other

#### **IX. DIRECTORS’ REPORTS & COMMENTS**

1. Budget Committee – (Sarkovich, Dolby)
2. Technical Advisory Committee – (Marx, Petersen)
3. Capital Improvement Committee – (Petersen, Dolby)
4. Personnel Committee – (McRae, Dolby)

5. Public Relations Committee – (McRae, Dolby)
6. FOWD and SJWD 2x2 Ad-Hoc Committee – (McRae, Petersen)
7. FOWD and CWD 2x2 Ad-Hoc Committee – (McRae, Marx)
8. Corporate Yard Ad-Hoc Committee – (Sarkovich, Petersen)

**X. GENERAL MANAGER’S REPORT**

1. Maintenance Work Report
2. Capital Projects Status Report
3. Authorizations of Additional Funding
4. Water Transfer Status Report
5. Claims Against District
6. Employee Update
7. Water Issues – Update on Regional Involvement
8. Other

**XI. PUBLIC COMMENT**

**XII. CLOSED SESSION PURSUANT TO GOVERNMENT CODE SECTIONS 54954 AND 54956**

1. Conference with legal counsel on existing litigation; Government Code Sections 54954.5 and 54956.9; Citrus Heights Water District & Fair Oaks Water District v. San Juan Water District; Sacramento Superior Court Case No. 24WM000064
2. Conference on Anticipated Litigation; Government Code Section 54956.9(d) – one case

**XIII. REPORT FROM CLOSED SESSION**

**XIV. PUBLIC COMMENT**

*I, Tom R. Gray, Secretary of the Fair Oaks Water District, do hereby certify that this agenda has been posted at 10326 Fair Oaks Blvd., Fair Oaks, California 72 hours prior to the regular meeting of the Board of Directors in accordance with Government Code Section 54950.5, the Ralph M. Brown Act.*

  
\_\_\_\_\_  
Tom R. Gray / Secretary  
General Manager

05-16-2024  
Date

**May 20, 2024**

**Staff Report Briefing Materials**

**AGENDA ITEM III.1a**

**Approval of Minutes of the Regular Board Meeting of April 15, 2024**



**District Attendees**

Chris Petersen	President
Mark Dolby	Vice President
Randy Marx	Board Member
Michael McRae	Board Member
Misha Sarkovich	Board Member
Tom R. Gray	General Manager
Shawn Huckaby	Operations Manager
Chi Ha-Ly	Finance Manager
Paul Siebensohn	Technical Services Manager
Rebecca Simon	Human Resource Administrator
Nick Kepler	Operations Superintendent

**Other Attendees**

Paul Helliker	SJWD General Manager
Brett Jones	JJACPA, Inc. Engagement Manager
George Babcock	Visiting Customer
Leon Corcos	Visiting Customer
Terry Erlewn	Water Resource Engineer/SJWD Board of Director Candidate
Roger CanField	Visitor
Joe M.	Visitor

**Absent**

**AGENDA ITEMS**

**I. CALL TO ORDER**

- President Petersen called the meeting to order at 6:30 p.m.

**II. PUBLIC COMMENT**

- Visitor Erlewn introduced himself and stated he will be running for SJWD Board of Directors.
- Visitor CanField introduced himself.
- Visitor Corcos expressed his concerns about being unable to locate an independent needs analysis for the proposed Corporate Yard Project as well as an independent rate increase analysis regarding the validity of the 25% water rate increase over three years. He requested documentation of such and stated his disbelief of its existence. He also

addressed his concern regarding the lack of response from Board Members, except from President Petersen—he always responds. This is inexcusable. He expects a response every time he writes a letter. He would also like to know where he can find more information regarding the current lawsuit.

- Director Sarkovich advised Visitor Corcos to visit the FOWD website to obtain lawsuit information, as it is posted there. Director Sarkovich stated he read Visitor Corcos' email and is puzzled at his objective of moving the Corporate Yard somewhere else. Director Sarkovich stated that this is not the first time Visitor Corcos has attacked General Manager Gray's character and he does not understand how doing so helps in convincing the Board to go along with his plan. Director Sarkovich stated he will not engage in those type of emails.
- Visitor Corcos responded that when they presented to the Board last March, three out of the five Board Members already had their written response, even before their presentation began. He does not believe any of the Board Members will change their mind.
- Director Marx stated that when an argument is presented, he weighs the pros and cons. Before writing his response, he spent four to five months analyzing the situation and nothing new was presented that day. It was a close call, but he decided to move forward with the Corporation Yard Project. He is not set in his ways; he will always continue to listen.
- Director McRae stated that he tries not to engage in inflammatory emails. If this is the way he gets approached, he ignores it. He reminded Visitor Corcos of giving him one-on-one time. He spent about an hour and a-half to two hours listening to what Visitor Corcos wanted to share. Director McRae believes he has gone above and beyond with him, compared to other rate payers.
- SJWD General Manager Helliker commended FOWD for posting the Board Packet on the website. He also commented that there doesn't appear to be capacity for water transfer this year. There has been progress in the water forum agreement and the goal is to have a draft ready by this summer.
- Visitor Joe M. introduced himself and stated he has been working with East Bay Mud upgrading facilities. He inquired about the bids for the Corporate Yard Project.
- President Petersen responded that the Corporate Yard Project is currently at the permitting process stage with Sacramento County. No contractors have been selected yet.

### **III. CONSENT CALENDAR**

The following consent calendar items were considered and acted upon as follows:

1. Approval of Minutes
  - a. Regular Board Meeting of March 18, 2024
2. Accept and File Treasurer's Report for the month of March 2024
3. File Investment Report for the month of February 2024
4. Accept and File Financial Expense Report for the month of March 2024
  - President McRae inquired about the TPX expenses.

- Operations Manager Huckaby responded it is a routine monthly bill for internet services.
  - President Petersen inquired about Sierra National Construction expenses for Skyway Well as this project has been completed.
  - Technical Services Manager Siebensohn explained that it was a regular payment, and the retention payment is pending.
  - General Manager Gray stated that a Substantial Completion Notice has been submitted. A retention release check will be processed in the upcoming months. The Skyway Well Project has been completed.
5. Approval of Warrants
  6. Approval of Cal-Card Statements for the month of March 2024
  7. Approval of Board Expense Report for the month of March 2024

Director McRae moved to approve the consent calendar as presented.

Director Dolby seconded the motion.

Motion carried with the following votes: Dolby – aye, Marx – aye and McRae – aye, Petersen – aye, Sarkovich – aye.

#### **IV. PRESENTATIONS AND CORRESPONDENCE**

##### **1. Presentation by JJACPA, Inc. on Fair Oaks Water District’s Draft Comprehensive Annual Financial Audit for the year ended December 31, 2023**

- General Manager Gray mentioned this is JJACPA, Inc.’s fifth and last year auditing FOWD, as per policy, a new auditor will be selected.
- JJACPA, Inc. Engagement Manager Jones provided a summary of the audit process, their responsibilities as auditors and shared FOWD’s audit results. He stated that FOWD is in a strong financial position with no debt. He addressed questions from the public and Board Members.

#### **V. DISCUSSION AND ACTION ITEMS: OLD BUSINESS**

##### **1. Update and discussion on the 2023 SJWD Wholesale Master Plan**

- General Manager Gray shared that FOWD and Citrus Heights Water District (CHWD) will be jointly working on a final comment letter to be delivered to SJWD.

##### **2. Update on RFP to provide professional design services required to redrill and equip a new groundwater well at the existing Northridge Well Site in Fair Oaks**

- Information only, included in the Board Packet.
- General Manager Gray thanked President Petersen for his input.
- Technical Services Manager shared he received an email from Luhdorff & Scalmanini Consulting Engineers stating this has been the most straightforward RFP they have seen in a very long time. This comment was made by someone working in the industry for thirty (30) years.
- General Manager Gray addressed questions and concerns from the Board.

**3. Discussion and possible action on the New York Water Main Replacement Projects**

- General Manager Gray provided a summary and presented Staff's recommendation.

Director Sarkovich moved to approve the New York Water Main Replacement Projects as presented.

President Petersen seconded the motion.

Motion carried with the following votes: Dolby – aye, Marx – aye and McRae – aye, Petersen – aye, Sarkovich – aye.

**VI. DISCUSSION AND ACTION ITEMS: NEW BUSINESS**

**1. Discussion and possible action to accept and file the Fair Oaks Water District's Annual Comprehensive Financial Report (ACFR), with Independent Auditor's Report, for the years ended December 31, 2023 & 2022**

Director Sarkovich moved to approve the ACFR as presented.

President Petersen seconded the motion.

Motion carried with the following votes: Dolby – aye, Marx – aye and McRae – aye, Petersen – aye, Sarkovich – aye.

**2. Discussion on FOWD Water Supply for the month of March 2024**

- Technical Services Manager Siebensohn provided a summary of the water supply report.
- Director McRae suggested changing the color of the bar depicting the 2024 Total Consumption, as it blends in with the background.
- Technical Services Manager Siebensohn indicated this change will be made.

**3. Public disclosure and discussion on press release "Water Agencies File Lawsuit to Protect Water Rates and Local Control"**

- Information only.
- General Manager Gray provided a brief summary and stated that a copy of the lawsuit and the press release can be found on FOWD's website.
- SJWD General Manager Helliker provided the Board with copies of SJWD's news release, posted on their website on April 12, 2024. SJWD will be responding to the lawsuit. He provided comments on FOWD's press release.

**4. Update and discussion on the combination of SSWD and CWD into one water purveyor**

- General Manager Gray stated that on March 26, 2024, CMD held a Special Board Meeting to discuss the merger between SSWD and CMD. CMD Board voted 4:1 to cease the merger discussion with SSWD.
- General Manager Gray stated that SSWD was contacted by SJWD with interest in reinitiating the discussion of merging the two districts.



- General Manager Gray explained that CMW decided not to move forward with the merger to protect their surface water rights. There was an immediate pivot to get surface water rights from another agency.
- SJWD General Manager Helliker stated that General Manager Gray was quoting from a SSWD staff report presented at their Board Meeting. SSWD had an agenda item to consider initiating a merger conversation with SJWD. This is something SJWD will address if SSWD decides to pursue it.
- General Manager Gray stated that SSWD's report indicates that SJWD initiated the discussion of a potential merger.
- SJWD General Manager Helliker stated that no one from his staff has had any conversations with SSWD. He is unsure as to what SSWD was referring to.
- For the record, General Manager Gray stated that this meeting is being recorded. He inquired if SJWD General Manager Helliker believes SSWD's General Manager is misinformed and misrepresented.
- SJWD General Manager Helliker stated that he is unsure what SSWD's General Manager was referring to in that statement. SSWD's General Manager could have been referring to conversations he has had with SJWD Board Members. SJWD General Manager Helliker guarantees there has been no conversations with his staff.
- Board President Petersen inquired what would be the need or benefit for SJWD to merge, instead of remaining independent. This is a topic of discussion that has come up in the past.
- SJWD General Manager Helliker referred to a 2014 report. This report argued that a merger would make it administratively easier to share water. However, this was not a detailed analysis. In order to consider the idea of a merger, a full case analysis would need to be conducted.
- President Petersen stated that the ongoing discussion of a potential merger has soured the relationship between SJWD and FOWD. FOWD was hopeful for a conjunctive use agreement. A SJWD Board Member expressed it was a waste of time. However, SJWD seems interested in a conjunctive use agreement, but with another entity. It would make more sense for SJWD to work with a wholesale customer. FOWD remains interested in this agreement.
- SJWD General Manager Helliker stated the comments made by SJWD's Board Members were inaccurate.

##### **5. Update on the FOWD Corporation Yard Redevelopment Project**

- General Manager Gray provided an update. The project is currently undergoing the planning and approval process with Sacramento County.
- Director Sarkovich commented that FOWD has been receiving invoices from different branches of Sacramento County, which indicates they are actively working and reviewing the project.
- Visitor Corcos mentioned there should have been more community involvement with the planning of this project. He expressed his discontent about the parking structure; it's not beneficial for the community.

- Director Sarkovich stated FOWD is trying to build an asset for the community. The traffic design will not be changed.
- Visiting Customer Babcock stated the lack of parking at the village is due to too many restaurants that do not provide adequate parking for their customers. Visitor Corcos owns some of these properties.

**VII. UPCOMING EVENTS**

- 1. April 16, 2024 / SJWD Finance Committee Meeting / SJWD Office**
- 2. April 24, 2024 / SJWD Board Meeting / SJWD Office**
  - General Manager Gray mentioned that FOWD and CHWD are still working on drafting a comment letter regarding SJWD’s strategic plan. Together, FOWD and CHWD represent over 50% of SJWD’s wholesale revenue and over 50% of their customer base, representing the majority of their funding and their customers.
- 3. May 9, 2024 / RWA Board Meeting / Sacramento**
  - President Petersen stated that an RFP was created for a water shed study, grant was received from DWR.
- 4. May 7-9, 2024 / ACWA Spring Conference / Sacramento**
  - General Manager Gray would like to attend and encouraged Board Members to attend. President Petersen and Director McRae mentioned they would like to attend as well.
- 5. June 13, 2024 / SGA Board Meeting / Sacramento**
  - Director Marx attended last Board Meeting and provided a brief report.
- 6. June 23-26 / CSDA GM Leadership Summit / Anaheim**
  - General Manager Gray will be attending.

**VIII. REPRESENTATIVE REPORTS**

- 1. Sacramento Groundwater Authority (SGA)**
  - None.
- 2. Regional Water Authority (RWA)**
  - None.
- 3. Sacramento Water Forum**
  - None.
- 4. Other**
  - None.

## **IX. DIRECTORS' REPORTS & COMMENTS**

- 1. Budget Committee – (Sarkovich, Dolby)**
  - None.
- 2. Technical Advisory Committee – (Marx, Petersen)**
  - None.
- 3. Capital Improvement Committee – (Sarkovich, Dolby)**
  - None.
- 4. Personnel Committee – (McRae, Petersen)**
  - None. A meeting will be scheduled in June 2024.
- 5. Public Relations Committee – (McRae, Dolby)**
  - None.
- 6. FOWD and SJWD 2x2 Ad-Hoc Committee – (McRae, Petersen)**
  - None.
- 7. FOWD and CWD 2x2 Ad-Hoc Committee – (McRae, Marx)**
  - None.
- 8. Corporate Yard Ad-Hoc Committee – (Sarkovich, McRae)**
  - None.

## **X. GENERAL MANAGER'S REPORT**

- 1. Maintenance Work Report**
  - Report provided.
- 2. Capital Projects Status Report**
  - Report provided.
- 3. Authorizations of Additional Funding**
  - Report provided.
- 4. Water Transfer Status Report**
  - None.
- 5. Claims Against District**
  - Report provided.
- 6. Employee Update**
  - General Manager Gray and Operations Manager Huckaby provided a staffing update.

**7. Water Issues – Update on Regional Involvement**

- None.

**8. Other**

- None.

**XI. PUBLIC COMMENT**

- Visiting Customer Babcock commented that for any Fair Oaks residents visiting Fair Oaks Recreation & Park District (FOPRD), it's easier and closer to park on the East-end. There is an unspoken advantage to putting the parking lot on the West side for the two evening restaurants that are owned by the advocate of moving the yard. If one of those establishments does not survive, that person gets less income. He believes there was an error in seeking multiple evening eating establishments in that property, as opposed to mixing it with more of a day-time establishment; having only one restaurant. There is not enough parking for multiple evening restaurants. There is an invested financial interest for the owner of this property. Modifying the current plans and resubmitting them to the county will be costly.
- General Manager Gray stated that FOWD works with the homes located on the North side. Operations cannot be moved to the East side because FOWD does not have an agreement with those homes. FOWD's mission statement is to serve water. FOWD is not a parking business. FOWD is a self-contained entity.
- Visiting Customer Babcock thanked the Board of Directors and the Management Team and stated that they are doing a splendid job.

President Petersen closed the open session meeting at 8:34 p.m.

President Petersen opened the closed session meeting at 8:34 p.m.

**XII. CLOSED SESSION PURSUANT TO GOVERNMENT CODE SECTIONS 54954 AND 54956**

1. Conference with legal counsel on existing litigation; Government Code Sections 54954.5 and 54956.9; Citrus Heights Water District & Fair Oaks Water District v. San Juan Water District; Sacramento Superior Court Case No. 23WM000080
2. Conference on Anticipated Litigation; Government Code Section 54956.9(d) – two cases

President Petersen closed the closed session meeting at 9:34 p.m.

President Petersen reopened the meeting to the public at 9:34 p.m.

**XIII. REPORT FROM CLOSED SESSION**

- None.

**XIV. PUBLIC COMMENT**

- None.

**XV. ADJOURNMENT**

With no further business to come before the Board, President Petersen adjourned the meeting at 9:34 p.m.



**May 20, 2024**

**Staff Report Briefing Materials**

**AGENDA ITEM III.2**

**Accept and File Treasurer's Report for the month of April 2024**

**AGENDA ITEM III.2**

REGULAR Board Meeting May 20, 2024

---

To: Board of Directors

From: Chi Ha-Ly

Date: May 15, 2024

Subject: Accept and File Treasurer's Report for the month of April 2024

---

**Recommendation:**

None.

**Discussion:**

Attached you will find the Treasurer's report for the month of April 2024.

**Policy Implications:**

None.

**Fiscal Impact:**

None.



# Fair Oaks Water District

Treasurer's Report - April 30, 2024

Agenda Item III.2

Description	LAIF - remaining	General Fund U.S. Bank	Payroll Fund U.S. Bank (I)	Cash	Balance
<b>Designated and Undesignated Cash, March 31, 2024</b>	<b>\$10,069,183</b>	<b>\$211,942</b>	<b>\$8,404</b>	<b>\$2,450</b>	<b>\$10,291,979</b>
<b>Receipts</b>					
Deposit: Water Service		\$994,523			\$994,523
Deposit: Other		\$907			\$907
Interest Earnings	\$106,646				\$106,646
<b>Subtotal</b>	<b>\$106,646</b>	<b>\$995,430</b>	<b>\$0</b>	<b>\$0</b>	<b>\$1,102,076</b>
<b>Expenses</b>					
General Expenses		(\$234,462)			(\$234,462)
General Warrants		(\$720,222)			(\$720,222)
Payroll			(\$180,199)		(\$180,199)
Service Charges and Fees		(\$4,816)			(\$4,816)
<b>Subtotal</b>	<b>\$0</b>	<b>(\$959,500)</b>	<b>(\$180,199)</b>	<b>\$0</b>	<b>(\$1,139,699)</b>
<b>Transfers and Allocations</b>					
Net Transfer from or to LAIF	(\$300,000)	\$300,000			\$0
Transfer to Payroll		(\$256,500)	\$256,500		\$0
<b>Subtotal</b>	<b>(\$300,000)</b>	<b>\$43,500</b>	<b>\$256,500</b>	<b>\$0</b>	<b>\$0</b>
<b>Designated and Undesignated Cash, April 30, 2024</b>	<b>\$9,875,829</b>	<b>\$291,371</b>	<b>\$84,705</b>	<b>\$2,450</b>	<b>\$10,254,355</b>

I, Chi Ha-Ly, deposes and says, the foregoing is a true and accurate accounting of the Special Funds in my custody showing the amount of money received by me for said accounts, and the amount and items of expenditure from those accounts during the preceding month, pursuant to Section 24392 of the Water Code.

  
 Chi Ha-Ly, Finance Manager

5/15/2024  
 Date



**FAIR OAKS WATER DISTRICT**  
**Check Register**  
**April 2024**

<u>Check Number</u>	<u>Check Date</u>	<u>Vendor Name</u>	<u>Check Amount</u>	<u>Description</u>
<i>General Expenses</i>				
50638	4/3/2024	AVALON CUSTODIAL CARE	\$ 1,700.00	Janitorial Services
50639	4/3/2024	COUNTY OF SACRAMENTO	113.70	Utilities
50640	4/3/2024	ELEVATOR TECHNOLOGY, INC.	316.00	Elevator Maintenance
50641	4/3/2024	IRON MOUNTAIN RECORDS MANAGEMENT	364.20	Document Storage
50642	4/3/2024	INTEGRITY DATA, INC.	38.20	Dues & Subscription
50643	4/3/2024	LAFLEUR EXCAVATING, INC.	2,685.00	Meter Rental Refund
50644	4/3/2024	NEPTUNE TECHNOLOGY GROUP, INC.	497.26	Registers
50645	4/3/2024	PACE SUPPLY CORP.	906.61	Project Parts
50646	4/3/2024	CUSTOMER	26.88	Customer Refund
50647	4/3/2024	SMUD	2,118.15	Utilities
50648	4/3/2024	CUSTOMER	59.21	Customer Refund
50649	4/3/2024	VERIZON WIRELESS	351.16	Communications
50650	4/4/2024	BARE BONES WORKWEAR	94.72	Safety Gear
50651	4/4/2024	PURCHASE POWER	12.32	Postage Machine Supply
50652	4/4/2024	TPX COMMUNICATIONS	7,293.79	Communications
50653	4/11/2024	REGISTRY OF CHARITABLE TRUSTS	25.00	Dues & Subscription
* 50653 (VOIDED)	4/11/2024	REGISTRY OF CHARITABLE TRUSTS	(25.00)	Voided and Reissued with Check #50655
50654	4/11/2024	COUNTY OF SACRAMENTO	750.00	Permits - Corp. Yard
50655	4/11/2024	REGISTRY OF CHARITABLE TRUSTS	25.00	Dues & Subscription
50656	4/11/2024	SACRAMENTO AREA SEWER DISTRICT	7,449.13	Permits - Corp. Yard
50658	4/16/2024	A. TEICHERT & SON, INC.	1,104.76	Sand & Aggregate
50659	4/16/2024	AT&T MOBILITY	1,115.26	Communications
50660	4/16/2024	COUNTY OF SACRAMENTO	113.70	Utilities
50661	4/16/2024	CASTLE & KING ROCK & READY MIX	1,120.00	Sand & Aggregate
50662	4/16/2024	CUSTOMER	105.31	Customer Refund
50663	4/16/2024	FRANCHISE TAX BOARD	100.00	Wage Garnishment
50664	4/16/2024	FUSE 3 COMMUNICATIONS	6,695.00	IT Consulting
50665	4/16/2024	CUSTOMER	175.00	Toilet Rebate
50666	4/16/2024	CUSTOMER	350.00	Toilet Rebate
50667	4/16/2024	CUSTOMER	101.33	Customer Refund
50668	4/16/2024	MFS 529 SAVING PLAN	175.00	529 Education Fund
50669	4/16/2024	P G & E	298.26	Utilities

<u>Check Number</u>	<u>Check Date</u>	<u>Vendor Name</u>	<u>Check Amount</u>	<u>Description</u>
50670	4/16/2024	ADT COMMERCIAL	545.97	Security
50671	4/16/2024	PRINT PROJECT MANAGERS, INC.	366.35	Door Hanger Notices
50672	4/16/2024	PIP MARKETING, SIGNS, PRINT	519.68	Printing - Budget Report
50673	4/16/2024	SMUD	9,482.54	Utilities
50674	4/16/2024	SACRAMENTO VALLEY ALARM SECURITY	354.44	Security
50675	4/16/2024	TEK SUPPLY	18,840.62	Tarps for Corporate Yard
50676	4/16/2024	WASTE MANAGEMENT	615.29	Utilities
50677	4/16/2024	STAFF	275.00	Safety Boots
50678	4/16/2024	SMUD	1,708.85	Utilities
50679	4/17/2024	COUNTY OF SACRAMENTO	92.00	Encroachment
50680	4/17/2024	STAFF	225.00	Training/Seminars
50681	4/17/2024	CUSTOMER	99.33	Customer Refund
50682	4/23/2024	COUNTY OF SACRAMENTO	282.52	Inspection - Corp. Yard
* 50200 (VOIDED)	4/8/2024	CUSTOMER	(99.33)	Stale-Dated Check
* 50292 (VOIDED)	4/8/2024	CUSTOMER	(81.03)	Stale-Dated Check
* 50272 (VOIDED)	4/8/2024	CUSTOMER	(248.47)	Stale-Dated Check
REMIT0000000000004200	4/3/2024	BSK ASSOCIATES	44.00	Water Testing/Sampling
REMIT0000000000004201	4/3/2024	STREAMLINE	375.00	Website Maintenance
REMIT0000000000004202	4/3/2024	GRAINGER	38.95	Tools
REMIT0000000000004203	4/3/2024	PITNEY BOWES BANK INC-RESERVE	5,000.00	Postage
REMIT0000000000004207	4/16/2024	BSK ASSOCIATES	826.00	Water Testing/Sampling
REMIT0000000000004208	4/16/2024	COGSDALE	4,837.50	IT Consulting
REMIT0000000000004209	4/16/2024	CENTRAL VALLEY ENGINEERING & ASPHALT	2,076.00	Paving
REMIT0000000000004210	4/16/2024	CRAYON SOFTWARE EXPERTS LLC.	2,294.36	Azure Overages
REMIT0000000000004211	4/16/2024	HUNT & SONS LLC.	3,197.56	Gas & Oil
REMIT0000000000004212	4/16/2024	JJACPA, INC.	10,780.03	Financial Audit Fees
REMIT0000000000004213	4/17/2024	BURKETT'S OFFICE FURNISHINGS AND PRTINTING	269.32	Office Supplies
REMIT0000000000004214	4/29/2024	I.M.P.A.C. GOVERNMENT SERVICES	14,430.94	Credit Cards - See Cal-Card Summary for Details
WDL000006505	4/4/2024	PERS- RETIREMENT + RETRO	23,049.65	Retirement Contributions
WDL000006507	4/10/2024	EDD	8,649.08	State Payroll Taxes
WDL000006508	4/10/2024	IRS-EFTPS	38,857.64	Federal Payroll Taxes
WDL000006510	4/10/2024	EDD	77.54	State Payroll Taxes
WDL000006511	4/10/2024	EDD	223.72	State Payroll Taxes
WDL000006512	4/10/2024	IRS EFTPS	481.93	Federal Payroll Taxes

<u>Check Number</u>	<u>Check Date</u>	<u>Vendor Name</u>	<u>Check Amount</u>	<u>Description</u>
WDL000006513	4/10/2024	IRS EFTPS	958.36	Federal Payroll Taxes
WDL000006522	4/24/2024	IRS-EFTPS	25,587.55	Federal Payroll Taxes
WDL000006523	4/24/2024	EDD	4,919.28	State Payroll Taxes
WDL000006525	4/18/2024	PERS RETIREMENT	18,253.76	Retirement Contributions
<b>Total General Expenses</b>			<b>\$ 234,461.88</b>	

**General Warrants**

50657	4/15/2024	SAN JUAN WATER DISTRICT	\$ 485,519.95	Water Purchase
REMIT0000000000004205	4/15/2024	ACWA JPIA	66,659.11	Health/Dental/Vision/EAP/Life Insurance
REMIT0000000000004206	4/15/2024	CENTRAL VALLEY ENGINEERING & ASPHALT	168,042.90	Paving
<b>Total General Warrants</b>			<b>\$ 720,221.96</b>	

**Service Charges and Fees**

WDL000006519	4/1/2024	US BANK	\$ 100.98	Credit Card Fees
REMIT0000000000004204	4/4/2024	INVOICE CLOUD, INC.	2,347.00	Invoice Cloud Fees
WDL000006518	4/12/2024	US BANK	2,278.05	Analysis Fees
WDL000006536	4/30/2024	INVOICE CLOUD, INC.	90.43	Invoice Cloud/Payment Tech (Fees) Settled
<b>Total Service Charges and Fees</b>			<b>\$ 4,816.46</b>	

**Total Expenses** **\$ 959,500.30**

**May 20, 2024**

**Staff Report Briefing Materials**

**AGENDA ITEM III.3**

**File Investment Report for the month of March 2024**

**AGENDA ITEM III.3**

REGULAR Board Meeting on May 20, 2024

---

To: Board of Directors  
From: Chi Ha-Ly  
Date: May 15, 2024  
Subject: File Investment Report for the month of March 2024

---

**Recommendation:**

None.

**Discussion:**

Attached are the March 2024 LAIF monthly statement and LAIF monthly performance report. The April 2024 LAIF monthly performance report is not available for inclusion this month due to the timing of the Board meeting. The April 2024 LAIF monthly statement and LAIF monthly performance report will be included in the June 2024 Board Consent Calendar.

The District's cash flow is sufficient to meet the next six months of budgeted District expenses (Govt. Code 53646(b)(3)). The District's investment portfolio is in compliance with the investment policy (Govt. Code 53646(b)(2)).

**Policy Implications:**

None.

**Fiscal Impact:**

None.

California State Treasurer  
**Fiona Ma, CPA**



Local Agency Investment Fund  
P.O. Box 942809  
Sacramento, CA 94209-0001  
(916) 653-3001

April 04, 2024

[LAIF Home](#)  
[PMIA Average Monthly Yields](#)

---

FAIR OAKS WATER DISTRICT

TOM R. GRAY, GENERAL MANAGER  
10326 FAIR OAKS BLVD  
FAIR OAKS, CA 95628

[Tran Type Definitions](#)

⚡

**Account Number:**

March 2024 Statement

**Account Summary**

Total Deposit:	0.00	Beginning Balance:	10,069,182.91
Total Withdrawal:	0.00	Ending Balance:	10,069,182.91



# PMIA/LAIF Performance Report as of 4/17/24



### Quarterly Performance Quarter Ended 03/31/24

LAIF Apportionment Rate <sup>(2)</sup> :	4.30
LAIF Earnings Ratio <sup>(2)</sup> :	0.00011755619077389
LAIF Administrative Cost <sup>(1)*</sup> :	0.27
LAIF Fair Value Factor <sup>(1)</sup> :	0.994191267
PMIA Daily <sup>(1)</sup> :	4.22
PMIA Quarter to Date <sup>(1)</sup> :	4.12
PMIA Average Life <sup>(1)</sup> :	226

### PMIA Average Monthly Effective Yields<sup>(1)</sup>

March	4.232
February	4.122
January	4.012
December	3.929
November	3.843
October	3.670

### Pooled Money Investment Account Monthly Portfolio Composition <sup>(1)</sup> 3/31/24 \$156.5 billion

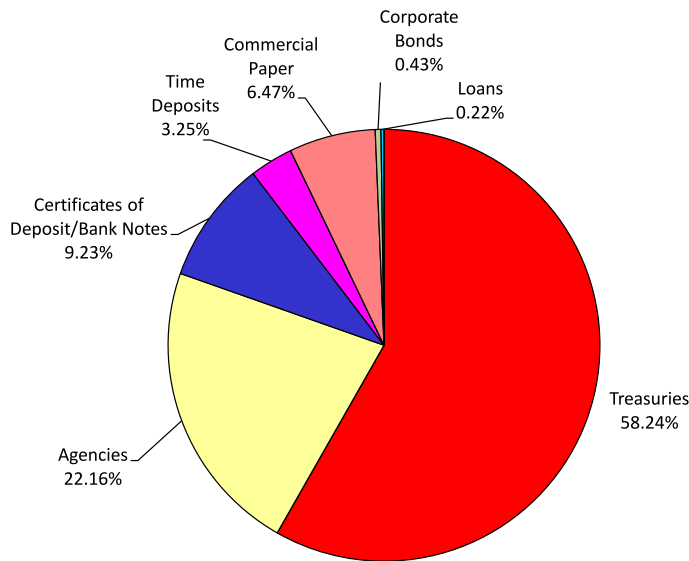

Chart does not include \$2,005,000.00 in mortgages, which equates to 0.001%. Percentages may not total 100% due to rounding.

Daily rates are now available here. [View PMIA Daily Rates](#)

Notes: The apportionment rate includes interest earned on the CalPERS Supplemental Pension Payment pursuant to Government Code 20825 (c)(1) and interest earned on the Wildfire Fund loan pursuant to Public Utility Code 3288 (a).

\*The percentage of administrative cost equals the total administrative cost divided by the quarterly interest earnings. The law provides that administrative costs are not to exceed 5% of quarterly EARNINGS of the fund. However, if the 13-week Daily Treasury Bill Rate on the last day of the fiscal year is below 1%, then administrative costs shall not exceed 8% of quarterly EARNINGS of the fund for the subsequent fiscal year.

Source:

<sup>(1)</sup> State of California, Office of the Treasurer

<sup>(2)</sup> State of California, Office of the Controller

**May 20, 2024**

**Staff Report Briefing Materials**

**AGENDA ITEM III.4**

**Accept and File Monthly Financial Expense Report for the month of April 2024**



---

**AGENDA ITEM III.4**

REGULAR Board Meeting May 20, 2024

---

To: Board of Directors  
From: Chi Ha-Ly  
Date: May 17, 2024  
Subject: Accept and File Financial Expense Report for the month of April 2024

---

**Recommendation:**

None at this time. Monthly financial expenses presented for informational purposes.

**Discussion:**

Attached is the financial report for the month of April 2024.

Please note that the monthly financial report is on a cash basis; therefore, a budgeted line item could be 100% expended as of April 2024.

As of April 2024, the District has 68.76% of remaining adjusted budget.

This report provides a quick snapshot of the operating expenses incurred by the District and does not include items that are capitalized (i.e. costs of construction jobs, fixed assets). The capital projects are reported separately under the “Capital Projects Status Report.”

**Policy Implications:**

None as a result of recommended action.

**Fiscal Impact:**

None as a result of recommended action.

**FAIR OAKS WATER DISTRICT**  
**Company Consolidation**  
For the Four Months Ending Tuesday, April 30, 2024

	April Actual	YTD Actual	Original Annual Budget	Adjusted Annual Budget	Remaining Adjusted Budget	% Remaining Adjusted Budget
<b>Labor</b>						
<b>Salaries and Wages</b>						
Salaries	\$271,574	\$872,371	\$3,301,100	\$3,301,100	\$2,428,729	73.57%
<b>Salaries and Wages Subtotal</b>	<b>\$271,574</b>	<b>\$872,371</b>	<b>\$3,301,100</b>	<b>\$3,301,100</b>	<b>\$2,428,729</b>	<b>73.57%</b>
<b>Benefits and Insurance</b>						
Auto Fringe Benefits	\$300	\$1,200	\$3,600	\$3,600	\$2,400	66.67%
Dental Insurance	2,868	14,211	44,900	44,900	30,689	68.35%
FICA	16,014	57,114	204,700	204,700	147,586	72.10%
Medicare	3,745	13,357	47,900	47,900	34,543	72.11%
Health Insurance	61,839	307,776	829,500	829,500	521,724	62.90%
Disability Insurance		2,479	13,200	13,200	10,721	81.22%
Life Insurance	705	3,511	8,500	8,500	4,989	58.70%
Pension Plan	23,977	84,981	620,900	620,900	535,919	86.31%
Deferred Compensation**		45,650	41,400	45,650		0.00%
Unemployment Insurance		15,000	15,000	15,000	15,000	100.00%
Vision Care	703	3,492	9,400	9,400	5,908	62.85%
Worker's Compensation	5,901	19,150	83,000	83,000	63,850	76.93%
<b>Benefits &amp; Insurance Subtotal</b>	<b>\$116,051</b>	<b>\$552,920</b>	<b>\$1,922,000</b>	<b>\$1,926,250</b>	<b>\$1,373,330</b>	<b>71.30%</b>
Salaries & Benefits Capitalized	(\$20,879)	(\$85,685)	(\$803,200)	(\$803,200)	(\$717,515)	89.33%
Salaries & Benefits to Damages		(3,671)	(11,600)	(11,600)	(7,929)	68.36%
<b>Labor Total</b>	<b>\$366,746</b>	<b>\$1,335,935</b>	<b>\$4,408,300</b>	<b>\$4,412,550</b>	<b>\$3,076,615</b>	<b>69.72%</b>
<b>Materials and Services</b>						
<b>Water Supply</b>						
Surface Water Supply, SJWD	\$485,520	\$1,024,652	\$2,217,600	\$2,217,600	\$1,192,948	53.79%
Chemicals		2,019	32,600	32,600	30,581	93.81%
Division of Drinking Water Annual Permit**		64,482	64,000	64,500	18	0.03%
Energy Cost, Wells	13,769	47,050	424,300	424,300	377,250	88.91%
Energy Cost, Other	339	956	3,100	3,100	2,144	69.15%
Testing & Sampling	4,354	17,135	31,000	31,000	13,865	44.73%
SCADA Support & Maintenance		404	10,000	10,000	9,596	95.96%
Cathodic Protection			4,000	4,000	4,000	100.00%
Hydrant Testing & Flushing			3,000	3,000	3,000	100.00%
<b>Water Supply Subtotal</b>	<b>\$503,982</b>	<b>\$1,156,698</b>	<b>\$2,789,600</b>	<b>\$2,790,100</b>	<b>\$1,633,402</b>	<b>58.54%</b>
<b>District Facilities and Maintenance &amp; Repairs</b>						
Wells Repairs and Upgrades		\$3,547	\$24,000	\$24,000	\$20,453	85.22%
Skyway Tank Inspection			5,000	5,000	5,000	100.00%
Skyway Booster #1 Inspection and Repair			5,000	5,000	5,000	100.00%
Annual Pump Efficiency Testing			5,000	5,000	5,000	100.00%
Tank Repairs and Maintenance	205	205	15,000	15,000	14,795	98.64%
District Site Maintenance	1,466	5,109	20,000	20,000	14,891	74.46%
Janitorial	1,774	7,023	23,000	23,000	15,977	69.47%
Elevator Maintenance*	316	2,114	9,500	10,125	8,011	79.12%
Security Costs	909	2,098	4,200	4,200	2,102	50.05%
<b>District Facilities Maint. Subtotal</b>	<b>\$4,670</b>	<b>\$20,095</b>	<b>\$110,700</b>	<b>\$111,325</b>	<b>\$91,230</b>	<b>81.95%</b>
<b>Vehicle and Equipment Maintenance</b>						
Vehicle Maintenance		\$4,026	\$16,500	\$16,500	\$12,474	75.60%
Vehicle Repairs*	1,762	4,154	15,000	15,000	10,846	72.30%
Other Equipment Maintenance	62	524	15,500	16,500	15,976	96.83%
Other Equipment Repair		5,044	15,000	15,000	9,956	66.37%
<b>Vehicle &amp; Equip. Maint. Subtotal</b>	<b>\$1,824</b>	<b>\$13,749</b>	<b>\$62,000</b>	<b>\$63,000</b>	<b>\$49,251</b>	<b>78.18%</b>
<b>Insurance</b>						
Auto and General Liability Insurance	\$500	\$500	\$115,000	\$115,000	\$114,500	99.57%
Bonding		1,500	1,600	1,600	100	6.25%
Property Insurance			45,000	45,000	45,000	100.00%
<b>Insurance Subtotal</b>	<b>\$500</b>	<b>\$2,000</b>	<b>\$161,600</b>	<b>\$161,600</b>	<b>\$159,600</b>	<b>98.76%</b>
<b>Printing and Postage</b>						
Advertisements & Legal Notices		\$180	\$5,000	\$5,000	\$4,820	96.40%
Online Bill Pay/Payment Processing	2,437	9,661	28,000	28,000	18,339	65.50%
Customer Bill Printing		1,784	17,500	17,500	15,716	89.80%
Customer Bill Postage	4,250	17,000	43,000	43,000	26,000	60.47%
Customer Collection Postage	700	2,800	7,000	7,000	4,200	60.00%
General Postage	50	200	1,000	1,000	800	80.00%
General Printing	886	886	1,800	1,800	914	50.78%
Collection Expense Printing		538	900	900	362	40.26%
<b>Printing and Postage Subtotal</b>	<b>\$8,323</b>	<b>\$33,049</b>	<b>\$104,200</b>	<b>\$104,200</b>	<b>\$71,151</b>	<b>68.28%</b>
<b>Office Expense and Other</b>						
Office Equipment Rental	\$151	\$302	\$700	\$700	\$398	56.79%
Office Supplies	674	4,968	17,000	17,000	12,032	70.78%
Office Equipment less than \$500		938	3,000	3,000	2,062	68.73%
Office Furniture less than \$500		252	2,000	2,000	1,748	87.41%
Office Equipment Maintenance			500	500	500	100.00%
Office Equipment Maintenance Agreements	2,533	5,948	18,100	18,100	12,152	67.14%
<b>Office Expense &amp; Other Subtotal</b>	<b>\$3,359</b>	<b>\$12,409</b>	<b>\$41,300</b>	<b>\$41,300</b>	<b>\$28,891</b>	<b>69.95%</b>
<b>Professional Services</b>						
Annual Audit Fees	\$10,780	\$18,780	\$22,000	\$22,000	\$3,220	14.64%
Actuarial services for pension calculation			800	800	800	100.00%

**FAIR OAKS WATER DISTRICT**  
**Company Consolidation**  
For the Four Months Ending Tuesday, April 30, 2024

	April Actual	YTD Actual	Original Annual Budget	Adjusted Annual Budget	Remaining Adjusted Budget	% Remaining Adjusted Budget
Meter Testing Service*		1,767	5,000	6,800	5,033	74.02%
Dues and Subscription	63	18,724	52,000	52,000	33,276	63.99%
Grant Application			5,000	5,000	5,000	100.00%
Hydraulic Model Update			11,000	11,000	11,000	100.00%
Urban Water Management Plan			15,000	15,000	15,000	100.00%
Emergency Response Plan			500	500	500	100.00%
Legal Fees		44,314	150,000	150,000	105,686	70.46%
Coop. Trans. Pipeline O&M			7,000	7,000	7,000	100.00%
Website Design and Public Outreach			5,000	5,000	5,000	100.00%
Regional Support			108,000	108,000	108,000	100.00%
Banking Fees	2,489	9,677	36,000	36,000	26,323	73.12%
IT Consulting Service	11,408	45,942	123,500	123,500	77,558	62.80%
Annual IT Audit			5,600	5,600	5,600	100.00%
Answering Service	171	694	2,500	2,500	1,806	72.24%
Other Professional Fees*	957	7,406	150,000	169,589	162,183	95.63%
<b>Professional Fees Subtotal</b>	<b>\$25,867</b>	<b>\$147,305</b>	<b>\$698,900</b>	<b>\$720,289</b>	<b>\$572,984</b>	<b>79.55%</b>
<b>System Maintenance/Repairs</b>						
Aggregate/Sand/Cutback	\$6,236	\$10,757	\$25,000	\$25,000	\$14,243	56.97%
Paving	7,796	7,796	75,000	75,000	67,204	89.61%
Equipment and Tool Rental			1,290	1,500	210	13.99%
General Maint., Supplies & Consumables	1,332	4,445	15,000	15,000	10,555	70.37%
Distribution Repairs	844	20,344	25,000	25,000	4,656	18.63%
Distribution System Maintenance Programs		76	7,000	7,000	6,924	98.91%
T-Main Repairs	286	757	25,000	25,000	24,243	96.97%
Damages	1,652	12,769	25,000	25,000	12,231	48.93%
Backflow Testing and Supplies	233	233	4,800	4,800	4,567	95.14%
Meter Downsize Repairs/Upgrades			600	600	600	100.00%
Inventory Replenishment			10,000	10,000	10,000	100.00%
Gas & Oil	5,975	15,437	56,000	56,000	40,563	72.43%
Equipment & Tools less than \$500		1,313	12,000	12,000	10,687	89.06%
Safety, Signs & Cones	1,535	4,461	13,000	13,000	8,539	65.68%
<b>System Maint./Repairs Subtotal</b>	<b>\$25,890</b>	<b>\$79,678</b>	<b>\$294,900</b>	<b>\$294,900</b>	<b>\$215,222</b>	<b>72.98%</b>
<b>Fees</b>						
State and County Fees			\$1,300	\$1,300	\$1,300	100.00%
Air Quality			10,900	10,900	10,900	100.00%
NPDES Permit			4,000	4,000	4,000	100.00%
Haz-mat Disposal			2,000	2,000	2,000	100.00%
Haz-mat Permit		380	6,900	6,900	6,520	94.50%
<b>Fees Subtotal</b>		<b>\$380</b>	<b>\$25,100</b>	<b>\$25,100</b>	<b>\$24,720</b>	<b>98.49%</b>
<b>Utilities</b>						
Telephone/Communication	\$8,293	\$32,133	\$101,900	\$101,900	\$69,767	68.47%
District Site Utilities	2,341	9,329	36,500	36,500	27,171	74.44%
<b>Utilities Subtotal</b>	<b>\$10,634</b>	<b>\$41,462</b>	<b>\$138,400</b>	<b>\$138,400</b>	<b>\$96,938</b>	<b>70.04%</b>
<b>Information Technology</b>						
Computer Software Maint. & Agreements	\$3,612	\$12,729	\$140,500	\$140,500	\$127,771	90.94%
Computer Hardware <\$500			5,000	5,000	5,000	100.00%
Computer Software <\$500			1,000	1,000	1,000	100.00%
<b>Information Technology Subtotal</b>	<b>\$3,612</b>	<b>\$12,729</b>	<b>\$146,500</b>	<b>\$146,500</b>	<b>\$133,771</b>	<b>91.31%</b>
<b>Water Efficiency</b>						
Conservation Outreach		\$500	\$22,000	\$22,000	\$21,500	97.73%
Cons. Landscape Irrigation Review			2,000	2,000	2,000	100.00%
Conservation Water Waste	39	39	500	500	461	92.21%
Conservation Large Landscape			2,000	2,000	2,000	100.00%
Conservation Toilet Rebate Program	250	1,038	10,000	10,000	8,962	89.62%
Conservation Toilet Rebate Program (Reimb.)	175	775	7,500	7,500	6,725	89.66%
Washing Machine Rebate Program		50	500	500	450	90.00%
Conservation Internal Review			1,000	1,000	1,000	100.00%
<b>Conservation Subtotal</b>	<b>\$465</b>	<b>\$2,402</b>	<b>\$45,500</b>	<b>\$45,500</b>	<b>\$43,098</b>	<b>94.72%</b>
<b>Training &amp; Uniforms</b>						
DMV/Physicals		\$775	\$8,500	\$8,500	\$7,725	90.89%
Employee Recognition Program	309	1,025	11,000	11,000	9,975	90.68%
Training, Travel and Expenses	1,627	2,821	20,000	20,000	17,179	85.90%
Uniforms	372	372	12,800	12,800	12,428	97.10%
<b>Training &amp; Uniforms Subtotal</b>	<b>\$2,308</b>	<b>\$4,992</b>	<b>\$52,300</b>	<b>\$52,300</b>	<b>\$47,308</b>	<b>90.45%</b>
<b>Board</b>						
Election Expense			\$45,400	\$45,400	\$45,400	100.00%
Director's Fees	\$1,000	\$3,200	\$12,500	\$12,500	\$9,300	74.40%
Miscellaneous Board Expenses	151	804	2,500	2,500	1,696	67.85%
Travel and Seminars			10,000	10,000	10,000	100.00%
<b>Board Subtotal</b>	<b>\$1,151</b>	<b>\$4,004</b>	<b>\$70,400</b>	<b>\$70,400</b>	<b>\$66,396</b>	<b>94.31%</b>
<b>Materials &amp; Services Total</b>	<b>\$592,585</b>	<b>\$1,530,952</b>	<b>\$4,741,400</b>	<b>\$4,764,914</b>	<b>\$3,233,963</b>	<b>67.87%</b>
<b>GRAND TOTAL</b>	<b>\$959,331</b>	<b>\$2,866,887</b>	<b>\$9,149,700</b>	<b>\$9,177,464</b>	<b>\$6,310,577</b>	<b>68.76%</b>

**FAIR OAKS WATER DISTRICT**  
**Company Consolidation**  
**For the Four Months Ending Tuesday, April 30, 2024**

	<u>April Actual</u>	<u>YTD Actual</u>	<u>Original Annual Budget</u>	<u>Adjusted Annual Budget</u>	<u>Remaining Adjusted Budget</u>	<u>% Remaining Adjusted Budget</u>
<b>CONTINGENCY FUND</b>		<b>\$76,335</b>	<b>\$200,000</b>	<b>\$200,000</b>	<b>\$123,665</b>	<b>61.83%</b>

\*The Board approved the following Project Fund to be carried forward from 2023 to 2024 at the January 16, 2024 Regular Board Meeting.  
 \$19,589.38 from Professional Services.  
 \$1,000 from Vehicle Repairs.  
 \$1,800 from Meter Testing Services.  
 \$625 from Elevator Maintenance.

\*\*Contingency Fund was used as follows:  
 \$500 was transferred to SWRCB-Division of Drinking Water Annual Permit - Board approved on January 16, 2024.  
 \$4,250 was transferred to Deferred Compensation - Board approved on January 16, 2024.  
 \$29,616 was transferred to Hazel Avenue Project #2004 - Board approved on March 18, 2024.  
 \$41,969 was transferred to Gum Ranch Unit 2 Project #1607 - Board approved on March 18, 2024.



---

**May 20, 2024**

**Staff Report Briefing Materials**

**AGENDA ITEM III.5**

**Approval of Warrants**

**AGENDA ITEM III.5**

REGULAR Board Meeting on May 20, 2024

To: Board of Directors  
 From: Tom R. Gray  
 Date: May 15, 2024  
 Subject: Approval of Warrants

**Recommendations:**

**Warrants**

Board of Directors approve the attached invoices listed below and authorize signing of warrants.

<b>ACWA JPIA</b>	
<i>Benefits - health, dental, vision, life, and Employee Assistance Program</i>	\$ 64,867.79
<b>Sierra National Construction</b>	
<i>Skyway Well Phase 2 - Retention Payment</i>	206,632.40
<b>Pace Supply Corp.</b>	
<i>Parts for Hydrant Upgrades</i>	29,826.39
<b>Total Warrants</b>	<b>\$ 301,326.58</b>

Board of Directors approve the attached purchase authorization(s) listed below and authorize purchase(s).

<b>Central Valley Engineering &amp; Asphalt, Inc.</b>	
<i>Paving for T-Main repairs, minor main upgrades, and distribution system repairs</i>	\$ 206,529.38
<b>Total Purchases</b>	<b>\$ 206,529.38</b>



---

Tom R. Gray, General Manager



Fair Oaks Water District, 000532  
Coverage Month: June 2024

Invoice Number: 0702747

Invoice Date: 05/02/2024

	Medical	Dental	Vision	Life	EAP	Totals
Insured Employees	28	28	28	28	28	
Previous Balance						\$66,659.11
Payment						(866,659.11)
Past Due Balance						\$0.00
Current Period Premium	\$61,169.95	\$2,832.55	\$679.00	\$985.46	\$69.44	\$65,736.40
Adjustment	-\$880.90	-\$35.36	-\$24.25	\$74.38	-\$2.48	-\$868.61
Benefit Totals	✓ \$60,289.05	✓ \$2,797.19	✓ \$654.75	✓ \$1,059.84	✓ \$66.96	\$64,867.79
<b>Total Due 06/01/2024</b>						<b>\$64,867.79</b>

*R Simon*  
5/9/2024

### Important Reminders

Visit [www.jpia.bswift.com](http://www.jpia.bswift.com) to download invoices, make enrollment changes, run reports and more.

Qualifying events for permitted changes outside the open enrollment period include: Divorce or legal separation, loss of coverage under a spouse's plan, death of spouse or dependent, marriage, birth or adoption.

**Benefit elections must be entered into bswift within 31 days of the benefits effective date.** The only exception is COBRA, which may be elected within 60 days.

If you have questions about your invoice or the bswift system, call us at 800-736-2292 or email [benefits@acwajpia.com](mailto:benefits@acwajpia.com).

**COPY**

Thank you for choosing ACWA JPIA.

CY Budget: \$1,881,350.00 Project No: E24 BIINS  
 Expenses TD: \$359,067.24 Cost Cat: VARIOUS  
 Committed Cost: \$ Avail Budget: 1,522,282.71  
 Completed By: *R Simon* Date: 5/9/2024  
 Authorized By: \_\_\_\_\_ Date: \_\_\_\_\_  
 Authorized By: *JPK* Date: 5-10-2024

Keep this summary for your records.

*Cfe 5/13/24*

Please mail this payment stub with your check or money order made payable to: ACWA JPIA

Please remit to:  
ACWA JPIA  
PO Box 619082  
Roseville, CA 95661-9082

Make checks payable to ACWA JPIA. Please pay the invoiced amount.

Any unpaid portion that becomes more than 60 days past due will be subject to a 1% late charge each month.

Please pay separately from other JPIA programs.

Fair Oaks Water District  
10326 Fair Oaks Blvd  
Fair Oaks, CA 95628

Client Code	532
Payment Due Date	06/01/2024
Total Due on or before 06/01/2024	\$64,867.79

*R Simon*  
5/9/2024

Invoice Number: 0702747

Invoice Date: 05/02/2024

*JPK*  
5-10-2024

**COPY**

# SIERRA NATIONAL CONSTRUCTION

# RETENTION INVOICE

5433 El Camino Ave. Ste. 4  
Carmichael, CA 95608

Phone: (916)481-6792  
Fax: (916)482-2207

Fair Oaks Water District  
10326 Fair Oaks Blvd.

Fair Oaks, CA 95628

Invoice as of: 4/16/2024

Invoice Dt	Due Date	Invoice No.	Job Information		Retainage
8/11/2022	9/10/2022	12104-1	12104	Skyway Well Phase 2	\$25,900.00
9/9/2022	10/9/2022	12104-2	12104	Skyway Well Phase 2	\$8,800.00
10/13/2022	11/12/2022	12104-3	12104	Skyway Well Phase 2	\$29,207.60
11/8/2022	12/8/2022	12104-4C	12104	Skyway Well Phase 2	\$11,525.00
2/15/2023	3/17/2023	12104-5	12104	Skyway Well Phase 2	\$8,162.00
4/10/2023	5/10/2023	12104-6.	12104	Skyway Well Phase 2	\$6,000.00
5/22/2023	6/21/2023	12104-7	12104	Skyway Well Phase 2	\$42,621.30
6/26/2023	7/26/2023	12104-8	12104	Skyway Well Phase 2	\$11,125.00
7/10/2023	8/9/2023	12104-7C	12104	Skyway Well Phase 2	\$4,735.70
8/23/2023	9/22/2023	12104-9C	12104	Skyway Well Phase 2	\$32,867.40
9/15/2023	10/15/2023	12104-10	12104	Skyway Well Phase 2	\$15,309.00
11/16/2023	12/16/2023	12104-11	12104	Skyway Well Phase 2	\$1,726.00
3/6/2024	4/5/2024	12104-12C2	12104	Skyway Well Phase 2	\$8,157.40
4/16/2024	5/16/2024	12104-13	12104	Skyway Well Phase 2	\$496.00

CY Budget: \$ 341,966.37 Project No: C24 WT SDE  
 Expenses TD: \$ 101,452.52 Cost Categ: Professional  
 Committed Cost: \$ 3,294.00 Avail Budget: 237,219.50  
 Completed By: Amritpal Date: 05/09/24  
 Authorized By: [Signature] Date: 5/10/2024  
 Authorized By: [Signature] Date: 5-13-2024

Aging 1	Aging 2	Aging 3	Over 90 Days
\$4,464.00	\$0.00	\$0.00	\$0.00

Retainage Due: \$206,632.40

[Signature]  
5-13-2024



**Pace Supply Corp.**  
**P.O. Box 744915**  
**Los Angeles, CA 90074-4915**  
**Multiple Invoices for Warrant Approval**

<b>Invoice #</b>	<b>Dated</b>	<b>Amount</b>
069309950-1	4/10/2024	\$ 585.64 ✓
069417415	4/11/2024	5,740.42 ✓
069417402	4/11/2024	5,740.42 ✓
069417408	4/11/2024	5,740.42 ✓
069417400	4/11/2024	5,688.84 ✓
069417394	4/11/2024	5,740.42 ✓
069417421	4/11/2024	590.23 ✓
<b>Total</b>		<b><u>\$ 29,826.39</u></b>

*SRB*  
5-02-2024

PACE Supply Corp  
P.O. Box 744915  
Los Angeles, CA 90074-4915



# INVOICE

INVOICE DATE	INVOICE #	PAGE
04/10/24	069309950-1	1 of 1

DATE SHIPPED	CUSTOMER #
04/10/24	04975-00

Branch Contact: 916-386-8347 FAX: 916-386-8674  
Accounting & Credit: 855-306-5689

SHIP TO

FAIR OAKS WATER DIST  
ATTN: ACCTS PAYABLE  
10326 FAIR OAKS BLVD  
FAIR OAKS, CA 95628

FAIR OAKS WATER DIST  
ATTN: ACCTS PAYABLE  
10326 FAIR OAKS BLVD  
FAIR OAKS, CA 95628

CUSTOMER PURCHASE ORDER 8755	JOB NAME	SHIPPED VIA OUR TRUCK	TERMS 2%10TH NET 25TH	TAXABLE ITEMS
---------------------------------	----------	--------------------------	--------------------------	------------------

PART/DESCRIPTION	ORDER	SHIP	UNIT PRICE	EXTENSION	
FORB11444WNL 1 FIP X FIP LF BRS BALL VLV CURB STOP W/ LW FORD	3	3	98.7900	296.37	Y
FORC8444QNL 1 MIP X COMP CTS Q LF BRS CPLG FORD	50	11	20.2500	222.75	Y
FORC1444QNL 1 FIP X COMP CTS Q LF BRS CPLG FORD ⚠ WARNING: The products you have purchased can expose you to chemicals and/or substances, which are known to the State of California to cause cancer and birth defects or other reproductive harm. For more information, go to <a href="http://www.P65Warnings.ca.gov">www.P65Warnings.ca.gov</a>	1	1	24.4000	24.40	Y

Remit to: PACE Supply Corp P.O. Box 744915 Los Angeles, CA 90074-4915  
DUE TO THE SUSTAINED SURGE IN FUEL PRICES, EFFECTIVE IMMEDIATELY, WE ARE INCREASING OUR STANDARD DELIVERY FEE FROM \$10 TO \$15. LIMIT ONE FEE PER DAY, PER JOB.,

PO Number: 8775  
RCT Number:  
INVENTORY  
NON INVENTORY  
cf 4/10/24

THIS INVOICE IS SUBJECT TO ALL TERMS AND CONDITIONS ON THE FACE AND REVERSE	GROSS 543.52	TAX% 7.750	SALES TAX 42.12	SHIPPING & HANDLING 0.00	OTHER CHARGES 0.00	INVOICE TOTAL 585.64
---	-----------------	---------------	--------------------	-----------------------------	-----------------------	-------------------------

TO VIEW ONLINE GO TO: <a href="https://pacesupply.billtrust.com">https://pacesupply.billtrust.com</a>	USE THIS ENROLLMENT TOKEN: ZDR PHS TVR	BILLTRUST ACCOUNT #	04975
---	--	---------------------	-------

A discount amount of 11.71 is offered if your payment via check, ACH or cash is received by 05/10/2024.

Material Signed for by: Joe 04/10/24

PACE Supply Corp  
P.O. Box 744915  
Los Angeles, CA 90074-4915



INVOICE

INVOICE DATE	INVOICE #	PAGE
04/11/24	069417415	1 of 1

DATE SHIPPED	CUSTOMER #
04/11/24	04975-00

Branch Contact: 916-386-8347 FAX: 916-386-8674  
Accounting & Credit: 855-306-5689

SHIP TO

FAIR OAKS WATER DIST  
ATTN: ACCTS PAYABLE  
10326 FAIR OAKS BLVD  
FAIR OAKS, CA 95628

FAIR OAKS WATER DIST  
ATTN: ACCTS PAYABLE  
10326 FAIR OAKS BLVD  
FAIR OAKS, CA 95628

CUSTOMER PURCHASE ORDER <b>88868</b>	JOB NAME	SHIPPED VIA <b>OUR TRUCK</b>	TERMS <b>2%10TH NET 25TH</b>	TAXABLE ITEMS
---	----------	---------------------------------	---------------------------------	------------------

PART/DESCRIPTION	ORDER	SHIP	UNIT PRICE	EXTENSION	
PVPDR186 6 X 20 PVC C900 DR18 BLUE PIPE	20	20	14.3200	286.40	Y
FORFC2W6 6 DI 6.23-7.60 L7 ULTRA FLEX CPLG FORD	1	1	243.2800	243.28	Y
BRYM48 FIRE HYD BURY MJ 48 AC CL	1	1	446.8000	446.80	Y
FHD960W FIRE HYD WET CLOW 960 WHITE 2-2 1/2*4 1/2 ▲ WARNING: The products you have purchased can expose you to chemicals and/or substances, which are known to the State of California to cause cancer and birth defects or other reproductive harm. For more information, go to <a href="http://www.P65Warnings.ca.gov">www.P65Warnings.ca.gov</a>	1	1	4351.0600	4351.06	Y

Remit to: PACE Supply Corp P.O. Box 744915 Los Angeles, CA 90074-4915  
DUE TO THE SUSTAINED SURGE IN FUEL PRICES, EFFECTIVE IMMEDIATELY, WE ARE INCREASING OUR STANDARD DELIVERY FEE FROM \$10 TO \$15. LIMIT ONE FEE PER DAY, PER JOB.,

PO Number: 8871  
RCT Number: \_\_\_\_\_  
INVENTORY  
NON INVENTORY  
 4/24/24

THIS INVOICE IS SUBJECT TO ALL TERMS AND CONDITIONS ON THE FACE AND REVERSE	GROSS 5327.54	TAX% 7.750	SALES TAX 412.88	SHIPPING & HANDLING 0.00	OTHER CHARGES 0.00	INVOICE TOTAL 5740.42
---	------------------	---------------	---------------------	-----------------------------	-----------------------	--------------------------

TO VIEW ONLINE GO TO: <a href="https://pacesupply.billtrust.com">https://pacesupply.billtrust.com</a>	USE THIS ENROLLMENT TOKEN: ZDR PHS TVR	BILLTRUST ACCOUNT # 04975
---	--	---------------------------

A discount amount of 114.81 is offered if your payment via check, ACH or cash is received by 05/10/2024.

Material Signed for by: Gary 04/11/24

PACE Supply Corp  
P.O. Box 744915  
Los Angeles, CA 90074-4915



INVOICE

INVOICE DATE	INVOICE #	PAGE
04/11/24	069417402	1 of 1

DATE SHIPPED	CUSTOMER #
04/11/24	04975-00

Branch Contact: 916-386-8347 FAX: 916-386-8674  
Accounting & Credit: 855-306-5689

PO Number: 8870  
RCT Number: \_\_\_\_\_

SHIP TO

FAIR OAKS WATER DIST  
ATTN: ACCTS PAYABLE  
10326 FAIR OAKS BLVD  
FAIR OAKS, CA 95628

INVENTORY  
NON INVENTORY

*CP 4/24/24*

FAIR OAKS WATER DIST  
ATTN: ACCTS PAYABLE  
10326 FAIR OAKS BLVD  
FAIR OAKS, CA 95628

CUSTOMER PURCHASE ORDER	JOB NAME	SHIPPED VIA	TERMS	TAXABLE ITEMS		
8870		OUR TRUCK	2%10TH NET 25TH			
PART/DESCRIPTION		ORDER	SHIP	UNIT PRICE	EXTENSION	
PVPDR186 6 X 20 PVC C900 DR18 BLUE PIPE		20	20	14.3200	286.40	Y
FORFC2W6 6 DI 6.23-7.60 L7 ULTRA FLEX CPLG FORD		1	1	243.2800	243.28	Y
BRYM48 FIRE HYD BURY MJ 48 AC CL		1	1	446.8000	446.80	Y
FHD960W FIRE HYD WET CLOW 960 WHITE 2-2 1/2*4 1/2 ▲ WARNING: The products you have purchased can expose you to chemicals and/or substances, which are known to the State of California to cause cancer and birth defects or other reproductive harm. For more information, go to <a href="http://www.P65Warnings.ca.gov">www.P65Warnings.ca.gov</a>		1	1	4351.0600	4351.06	Y
Remit to: PACE Supply Corp P.O. Box 744915 Los Angeles, CA 90074-4915 DUE TO THE SUSTAINED SURGE IN FUEL PRICES, EFFECTIVE IMMEDIATELY, WE ARE INCREASING OUR STANDARD DELIVERY FEE FROM \$10 TO \$15. LIMIT ONE FEE PER DAY, PER JOB.,						

THIS INVOICE IS SUBJECT TO ALL TERMS AND CONDITIONS ON THE FACE AND REVERSE	GROSS	TAX%	SALES TAX	SHIPPING & HANDLING	OTHER CHARGES	INVOICE TOTAL
	5327.54	7.750	412.88	0.00	0.00	5740.42

TO VIEW ONLINE GO TO: <https://pacesupply.billtrust.com> USE THIS ENROLLMENT TOKEN: ZDR PHS TVR BILLTRUST ACCOUNT # 04975

A discount amount of 114.81 is offered if your payment via check, ACH or cash is received by 05/10/2024.

Material Signed for by: Gary 04/11/24

PACE Supply Corp  
P.O. Box 744915  
Los Angeles, CA 90074-4915



# INVOICE

INVOICE DATE	INVOICE #
04/11/24	069417408

PAGE  
1 of 1

DATE SHIPPED	CUSTOMER #
04/11/24	04975-00

Branch Contact: 916-386-8347 FAX: 916-386-8674  
Accounting & Credit: 855-306-5689

PO Number: 8869  
RCT Number: \_\_\_\_\_  
INVENTORY  
NON INVENTORY

SHIP TO

FAIR OAKS WATER DIST  
ATTN: ACCTS PAYABLE  
10326 FAIR OAKS BLVD  
FAIR OAKS, CA 95628

*ef. 4/24/24*

FAIR OAKS WATER DIST  
ATTN: ACCTS PAYABLE  
10326 FAIR OAKS BLVD  
FAIR OAKS, CA 95628

CUSTOMER PURCHASE ORDER	JOB NAME	SHIPPED VIA	TERMS	TAXABLE ITEMS		
8869		OUR TRUCK	2%10TH NET 25TH			
PART/DESCRIPTION		ORDER	SHIP	UNIT PRICE	EXTENSION	
PVPDR186 6 X 20 PVC C900 DR18 BLUE PIPE		20	20	14.3200	286.40	Y
FORFC2W6 6 DI 6.23-7.60 L7 ULTRA FLEX CPLG FORD		1	1	243.2800	243.28	Y
BRYM48 FIRE HYD BURY MJ 48 AC CL		1	1	446.8000	446.80	Y
FHD960W FIRE HYD WET CLOW 960 WHITE 2-2 1/2*4 1/2 ▲ WARNING: The products you have purchased can expose you to chemicals and/or substances, which are known to the State of California to cause cancer and birth defects or other reproductive harm. For more information, go to <a href="http://www.P65Warnings.ca.gov">www.P65Warnings.ca.gov</a>		1	1	4351.0600	4351.06	Y
Remit to: PACE Supply Corp P.O. Box 744915 Los Angeles, CA 90074-4915 DUE TO THE SUSTAINED SURGE IN FUEL PRICES, EFFECTIVE IMMEDIATELY, WE ARE INCREASING OUR STANDARD DELIVERY FEE FROM \$10 TO \$15. LIMIT ONE FEE PER DAY, PER JOB.,						

THIS INVOICE IS SUBJECT TO ALL TERMS AND CONDITIONS ON THE FACE AND REVERSE	GROSS	TAX%	SALES TAX	SHIPPING & HANDLING	OTHER CHARGES	INVOICE TOTAL
	5327.54	7.750	412.88	0.00	0.00	5740.42

TO VIEW ONLINE GO TO: <https://pacesupply.billtrust.com> USE THIS ENROLLMENT TOKEN: ZDR PHS TVR BILLTRUST ACCOUNT # 04975

A discount amount of 114.81 is offered if your payment via check, ACH or cash is received by 05/10/2024.

Material Signed for by: Gary 04/11/24

PACE Supply Corp  
P.O. Box 744915  
Los Angeles, CA 90074-4915



# INVOICE

INVOICE DATE	INVOICE #	PAGE
04/11/24	069417400	1 of 1

DATE SHIPPED	CUSTOMER #
04/11/24	04975-00

Branch Contact: 916-386-8347 FAX: 916-386-8674  
Accounting & Credit: 855-306-5689

SHIP TO

FAIR OAKS WATER DIST  
ATTN: ACCTS PAYABLE  
10326 FAIR OAKS BLVD  
FAIR OAKS, CA 95628

FAIR OAKS WATER DIST  
ATTN: ACCTS PAYABLE  
10326 FAIR OAKS BLVD  
FAIR OAKS, CA 95628

CUSTOMER PURCHASE ORDER	JOB NAME	SHIPPED VIA	TERMS	TAXABLE ITEMS		
8872		OUR TRUCK	2%10TH NET 25TH			
PART/DESCRIPTION		ORDER	SHIP	UNIT PRICE	EXTENSION	
PVPDR186 6 X 20 PVC C900 DR18 BLUE PIPE		20	20	14.3200	286.40	Y
FORFC2W6 6 DI 6.23-7.60 L7 ULTRA FLEX CPLG FORD		1	1	243.2800	243.28	Y
BRYM36 FIRE HYD BURY MJ 36 AC CL		1	1	398.9300	398.93	Y
FHD960W FIRE HYD WET CLOW 960 WHITE 2-2 1/2*4 1/2 △ WARNING: The products you have purchased can expose you to chemicals and/or substances, which are known to the State of California to cause cancer and birth defects or other reproductive harm. For more information, go to <a href="http://www.P65Warnings.ca.gov">www.P65Warnings.ca.gov</a>		1	1	4351.0600	4351.06	Y
Remit to: PACE Supply Corp P.O. Box 744915 Los Angeles, CA 90074-4915 DUE TO THE SUSTAINED SURGE IN FUEL PRICES, EFFECTIVE IMMEDIATELY, WE ARE INCREASING OUR STANDARD DELIVERY FEE FROM \$10 TO \$15. LIMIT ONE FEE PER DAY, PER JOB.,						

PO Number: 8872  
RCT Number: \_\_\_\_\_  
INVENTORY  
NON INVENTORY  
*CJF 4/24/24*

THIS INVOICE IS SUBJECT TO ALL TERMS AND CONDITIONS ON THE FACE AND REVERSE	GROSS	TAX%	SALES TAX	SHIPPING & HANDLING	OTHER CHARGES	INVOICE TOTAL
	5279.67	7.750	409.17	0.00	0.00	5688.84

TO VIEW ONLINE GO TO: <https://pacesupply.billtrust.com> USE THIS ENROLLMENT TOKEN: ZDR PHS TVR BILLTRUST ACCOUNT # 04975

A discount amount of 113.78 is offered if your payment via check, ACH or cash is received by 05/10/2024.

Material Signed for by: Gary 04/11/24

PACE Supply Corp  
P.O. Box 744915  
Los Angeles, CA 90074-4915



INVOICE

INVOICE DATE	INVOICE #	PAGE
04/11/24	069417394	1 of 1

DATE SHIPPED	CUSTOMER #
04/11/24	04975-00

Branch Contact: 916-386-8347 FAX: 916-386-8674  
Accounting & Credit: 855-306-5689

SHIP TO

FAIR OAKS WATER DIST  
ATTN: ACCTS PAYABLE  
10326 FAIR OAKS BLVD  
FAIR OAKS, CA 95628

FAIR OAKS WATER DIST  
ATTN: ACCTS PAYABLE  
10326 FAIR OAKS BLVD  
FAIR OAKS, CA 95628

CUSTOMER PURCHASE ORDER	JOB NAME	SHIPPED VIA	TERMS	TAXABLE ITEMS		
8868		OUR TRUCK	2%10TH NET 25TH			
PART/DESCRIPTION		ORDER	SHIP	UNIT PRICE	EXTENSION	
PVPDR186 6 X 20 PVC C900 DR18 BLUE PIPE		20	20	14.3200	286.40	Y
FORFC2W6 6 DI 6.23-7.60 L7 ULTRA FLEX CPLG FORD		1	1	243.2800	243.28	Y
BRYM48 FIRE HYD BURY MJ 48 AC CL		1	1	446.8000	446.80	Y
FHD960W FIRE HYD WET CLOW 960 WHITE 2-2 1/2*4 1/2 ⚠ WARNING: The products you have purchased can expose you to chemicals and/or substances, which are known to the State of California to cause cancer and birth defects or other reproductive harm. For more information, go to <a href="http://www.P65Warnings.ca.gov">www.P65Warnings.ca.gov</a>		1	1	4351.0600	4351.06	Y
Remit to: PACE Supply Corp P.O. Box 744915 Los Angeles, CA 90074-4915 DUE TO THE SUSTAINED SURGE IN FUEL PRICES, EFFECTIVE IMMEDIATELY, WE ARE INCREASING OUR STANDARD DELIVERY FEE FROM \$10 TO \$15. LIMIT ONE FEE PER DAY, PER JOB.,						

PO Number: 8868  
RCT Number: \_\_\_\_\_  
INVENTORY  
NON INVENTORY

*Chy* 4/24/24

THIS INVOICE IS SUBJECT TO ALL TERMS AND CONDITIONS ON THE FACE AND REVERSE	GROSS	TAX%	SALES TAX	SHIPPING & HANDLING	OTHER CHARGES	INVOICE TOTAL
	5327.54	7.750	412.88	0.00	0.00	5740.42

TO VIEW ONLINE GO TO: <https://pacesupply.billtrust.com> USE THIS ENROLLMENT TOKEN: ZDR PHS TVR BILLTRUST ACCOUNT # 04975

A discount amount of 114.81 is offered if your payment via check, ACH or cash is received by 05/10/2024.

Material Signed for by: Gary 04/11/24

PACE Supply Corp  
P.O. Box 744915  
Los Angeles, CA 90074-4915



# INVOICE

INVOICE DATE	INVOICE #
04/11/24	069417421

PAGE  
1 of 1

DATE SHIPPED	CUSTOMER #
04/11/24	04975-00

Branch Contact: 916-386-8347 FAX: 916-386-8674  
Accounting & Credit: 855-306-5689

SHIP TO

FAIR OAKS WATER DIST  
ATTN: ACCTS PAYABLE  
10326 FAIR OAKS BLVD  
FAIR OAKS, CA 95628

FAIR OAKS WATER DIST  
ATTN: ACCTS PAYABLE  
10326 FAIR OAKS BLVD  
FAIR OAKS, CA 95628

CUSTOMER PURCHASE ORDER	JOB NAME	SHIPPED VIA	TERMS	TAXABLE ITEMS		
8873		OUR TRUCK	2%10TH NET 25TH			
PART/DESCRIPTION		ORDER	SHIP	UNIT PRICE	EXTENSION	
DCFACCRETPVC6 6 RET WEDGE ACTION ACC PVC		6	6	60.6300	363.78	Y
WBLBS6 6 BOLT SET PLTD (8) 3/4 X 3 1/4		8	8	13.0000	104.00	Y
WBLBSHYDHOLLOW HYDRANT HOLLOW BOLT SET BREAK OFF (6) 5/8 X 3 ⚠ WARNING: The products you have purchased can expose you to chemicals and/or substances, which are known to the State of California to cause cancer and birth defects or other reproductive harm. For more information, go to <a href="http://www.P65Warnings.ca.gov">www.P65Warnings.ca.gov</a>		8	8	10.0000	80.00	Y
Remit to: PACE Supply Corp P.O. Box 744915 Los Angeles, CA 90074-4915 DUE TO THE SUSTAINED SURGE IN FUEL PRICES, EFFECTIVE IMMEDIATELY, WE ARE INCREASING OUR STANDARD DELIVERY FEE FROM \$10 TO \$15. LIMIT ONE FEE PER DAY, PER JOB.,						

PO Number: 8873  
 RCT Number: \_\_\_\_\_  
 INVENTORY  
 NON INVENTORY  
 cf 4/24/24

THIS INVOICE IS SUBJECT TO ALL TERMS AND CONDITIONS ON THE FACE AND REVERSE	GROSS	TAX%	SALES TAX	SHIPPING & HANDLING	OTHER CHARGES	INVOICE TOTAL
	547.78	7.750	42.45	0.00	0.00	590.23

TO VIEW ONLINE GO TO: <a href="https://pacesupply.billtrust.com">https://pacesupply.billtrust.com</a>	USE THIS ENROLLMENT TOKEN: ZDR PHS TVR	BILLTRUST ACCOUNT #	04975
---	--	---------------------	-------

A discount amount of 11.80 is offered if your payment via check, ACH or cash is received by 05/10/2024.

Material Signed for by: Gary 04/11/24



**Central Valley Engineering & Asphalt, Inc.**  
**216 Kenroy Lane**  
**Roseville, CA 95678**

**Multiple Purchases for Pre-Authorization**

<b>Reference #</b>	<b>Amount</b>
8921	\$ 30,335.00
8922	5,900.00
8926	5,700.00
2024-1	164,594.38
<b>Total</b>	<b>\$206,529.38</b>

*JKY*  
*05-15-2024*

FAIR OAKS WATER DISTRICT  
 10326 FAIR OAKS BLVD.  
 FAIR OAKS CA 95628

<b>Purchase Order</b>	
<b>Purchase Order No.</b>	PO000008921
<b>Date</b>	4/30/2024

**Vendor:**

Central Valley Engineering & Asphalt, Inc.  
 216 Kenroy Lane  
 Roseville, CA 95678

**Cal-Card Holder Name:**  
 Cal-Card Holder Name:  
 Date Purchased:  
 Will Invoice  
 Check RequesT:  
 FA To Order  
 missing receipt:

**Contract Number:**

^ Changed Since the Previous Revision

Shipping Method		Payment Terms		Confirm With		Page	
						1	
L/N	Item Number	Description	Req. Date	U/M	Ordered	Unit Price	Ext. Price
Project Number	Cost Category ID	Billing Note					
Shipping Method	Reference Number	FOB					
1	8982 LEEDY LN; 1573F C24TDSU PAVING	8982 LEEDY LN; 1573FT2 ASPHALT	4/30/2024	Each	1.00	\$18,900.00	\$18,900.00
2	9437 DRIFT WAY; 1941 C24TDSU PAVING	9437 DRIFT WAY; 194FT2 ASPHALT	4/30/2024	Each	1.00	\$2,500.00	\$2,500.00
3	9401 SHUMWAY DR; 1 C24TDSU PAVING	9401 SHUMWAY DR; 123FT2 ASPH	4/30/2024	Each	1.00	\$1,700.00	\$1,700.00
4	5004 RUNWAY DR; 11 C24TDSU PAVING	5004 RUNWAY DR; 111FT2 ASPH	4/30/2024	Each	1.00	\$1,575.00	\$1,575.00
5	5521 NORWAY DR; 11 C24TDSU PAVING	5521 NORWAY DR; 111FT2 ASPHA	4/30/2024	Each	1.00	\$1,575.00	\$1,575.00
6	3995 VILLA CT; 168FT; C24TDSU PAVING	3995 VILLA CT; 168FT2 ASPHALT	4/30/2024	Each	1.00	\$2,325.00	\$2,325.00
7	5523 BROME CT, 125F C24TDSU PAVING	5523 BROME CT, 125FT2 ASPHALT	4/30/2024	Each	1.00	\$1,760.00	\$1,760.00

<b>Subtotal</b>	\$30,335.00
<b>Trade Discount</b>	\$0.00
<b>Freight</b>	\$0.00
<b>Miscellaneous</b>	\$0.00
<b>Tax</b>	\$0.00
<b>Order Total</b>	\$30,335.00

Authorized Signature



**FAIR OAKS WATER DISTRICT  
PURCHASE AUTHORIZATION**

PLEASE PRINT

CAL-CARD HOLDER NAME: \_\_\_\_\_

DATE PURCHASED: \_\_\_\_\_

WILL INVOICE - PO# \_\_\_\_\_  FINANCE TO ORDER

CHECK REQUEST \_\_\_\_\_  MISSING RECEIPT

REQUESTOR TO ORDER \_\_\_\_\_

Name of Requestor: Josh Page Date of Request: 4/23/2024

Purchase Description: Paving Restoration - C24TDSU Date Needed By: ASAP

Vendor/Check Name: Central Valley Engineering & Asphalt, Inc Vendor Contact Name: Jamie Gruzas

Address: 216 Kenroy Lane, Roseville, CA 95678 Phone Number: 916-791-1609

Item#	Description	Quantity	Price Per Unit	Extended Price
	8982 Leedy Ln; 1573 ft <sup>2</sup> of Asphalt	1	\$18,900.00	\$ 18,900.00
	9437 Drift Way; 194 ft <sup>2</sup> of Asphalt	1	\$2,500.00	\$ 2,500.00
	9401 Shumway Dr; 123 ft <sup>2</sup> of Asphalt	1	\$1,700.00	\$ 1,700.00
	5004 Runway Dr; 111 ft <sup>2</sup> of Asphalt	1	\$1,575.00	\$ 1,575.00
	5521 Norway Dr; 111ft <sup>2</sup> of Asphalt	1	\$1,575.00	\$ 1,575.00
	3995 Villa Ct; 168 ft <sup>2</sup> of Asphalt	1	\$2,325.00	\$ 2,325.00
	5523 Brome Ct; 125 ft <sup>2</sup> of Asphalt	1	\$1,760.00	\$ 1,760.00

Subtotal: \$ 30,335.00

7.75% Tax: \_\_\_\_\_

Freight \$ -

Other \_\_\_\_\_ \$ -

Total: \$ 30,335.00

**Budget Availability (Authorized Personnel)**

Approved Budget: \$ 538,200.00 Project Number: C24TDSU

Expenses To Date: 179,262.17 Cost Category: PAVING

Committed Cost: - Completed By: JOSH PAGE

Budget Available: \$ 358,937.83 Date: 4/23/2024

**Purchase Recommendation (Supervisor)**

Print Name \_\_\_\_\_ Signature \_\_\_\_\_ Date \_\_\_\_\_

**Purchase Authorization (Manager, Superintendent)**

Verbal Authorization

**Nick Kepler**

Print Name \_\_\_\_\_ Signature \_\_\_\_\_ Date \_\_\_\_\_

**Purchase Authorization for All Purchases (Manager)**

Verbal Authorization

**Shawn Huckaby**

Print Name \_\_\_\_\_ Signature *[Signature]* Date 4/25/2024

**Purchase Authorization for \$10,000 or More (General Manager)**

Verbal Authorization

**Tom R. Gray**

Print Name \_\_\_\_\_ Signature *[Signature]* Date 5-01-2024

C147

FAIR OAKS WATER DISTRICT  
 10326 FAIR OAKS BLVD.  
 FAIR OAKS CA 95628

Purchase Order	
Purchase Order No.	PO000008922
Date	4/30/2024

**Vendor:**

Central Valley Engineering & Asphalt, Inc.  
 216 Kenroy Lane  
 Roseville, CA 95678

Cal-Card Holder Name:  
 Cal-Card Holder Name:  
 Date Purchased:  
 Will Invoice  
 Check Request:  
 FA To Order  
 missing receipt:

**Contract Number:**

^ Changed Since the Previous Revision

Shipping Method		Payment Terms		Confirm With		Page	
						1	
L/N	Item Number	Description	Req. Date	U/M	Ordered	Unit Price	Ext. Price
Project Number	Cost Category ID	Billing Note					
Shipping Method	Reference Number	FOB					
1	4532 PENNSYLVANIA ,		4/30/2024	Each	1.00	\$5,900.00	\$5,900.00
	C24TDMU PAVING	4532 PENNSYLVANIA AVE 490FT2	None				

C147

Subtotal	\$5,900.00
Trade Discount	\$0.00
Freight	\$0.00
Miscellaneous	\$0.00
Tax	\$0.00
Order Total	\$5,900.00

\_\_\_\_\_  
 Authorized Signature



# FAIR OAKS WATER DISTRICT PURCHASE AUTHORIZATION

PLEASE PRINT

<input type="checkbox"/>	CAL-CARD HOLDER NAME:	
<input type="checkbox"/>	DATE PURCHASED:	
<input checked="" type="checkbox"/>	WILL INVOICE - PO#	<input type="checkbox"/> FINANCE TO ORDER
<input type="checkbox"/>	CHECK REQUEST	<input type="checkbox"/> MISSING RECEIPT
<input type="checkbox"/>	REQUESTOR TO ORDER	

Name of Requestor: Josh Page Date of Request: 4/23/2024  
 Purchase Description: Paving Restoration - C24TDMU Date Needed By: ASAP  
 Vendor/Check Name: Central Valley Engineering & Asphalt, Inc Vendor Contact Name: Jamie Gruzaz  
 Address: 216 Kenroy Lane, Roseville, CA 95678 Phone Number: 916-791-1609

Item#	Description	Quantity	Price Per Unit	Extended Price
	4532 Pennsylvania Ave; 490 ft <sup>2</sup> of Asphalt	1	\$5,900.00	\$ 5,900.00
				\$ -
				\$ -
				\$ -
				\$ -

Subtotal: \$ 5,900.00  
 Tax: 7.75%  
 Freight \$ -  
 Other \$ -  
 Total: \$ 5,900.00

### Budget Availability (Authorized Personnel)

Approved Budget:	\$ 75,000.00	Project Number:	C24TDMU
Expenses To Date:	8,366.38	Cost Category:	PAVING
Committed Cost:	-	Completed By:	JOSH PAGE
Budget Available:	\$ 66,633.62	Date:	4/23/2024

### Purchase Recommendation (Supervisor)

Print Name	Signature	Date
------------	-----------	------

### Purchase Authorization (Manager, Superintendent)

Verbal Authorization

**Nick Kepler**  
 Print Name

Signature

Date

### Purchase Authorization for All Purchases (Manager)

Verbal Authorization

**Shawn Huckaby**  
 Print Name

*Shawn Huckaby*  
 Signature

4/25/2024  
 Date

### Purchase Authorization for \$10,000 or More (General Manager)

Verbal Authorization

**Tom R. Gray**  
 Print Name

Signature

Date

C147

FAIR OAKS WATER DISTRICT  
 10326 FAIR OAKS BLVD.  
 FAIR OAKS CA 95628

<b>Purchase Order</b>	
<b>Purchase Order No.</b>	PO000008926
<b>Date</b>	5/2/2024

**Vendor:**

Central Valley Engineering & Asphalt, Inc.  
 216 Kenroy Lane  
 Roseville, CA 95678

- Cal-Card Holder Name:**
- Cal-Card Holder Name:
- Date Purchased:
- Will Invoice
- Check Request:
- FA To Order
- missing receipt:

**Contract Number:**

^ Changed Since the Previous Revision

Shipping Method		Payment Terms		Confirm With			Page
							1
L/N	Item Number	Description	Req. Date	U/M	Ordered	Unit Price	Ext. Price
Project Number	Cost Category ID	Billing Note					
Shipping Method	Reference Number	FOB					
1	4901 MINNESOTA AVE		5/2/2024	Each	1.00	\$5,700.00	\$5,700.00
E24SMPAV	PAVING	4901 MINNESOTA AVE 333FT2	None				

C147

<b>Subtotal</b>	\$5,700.00
<b>Trade Discount</b>	\$0.00
<b>Freight</b>	\$0.00
<b>Miscellaneous</b>	\$0.00
<b>Tax</b>	\$0.00
<b>Order Total</b>	\$5,700.00

\_\_\_\_\_  
 Authorized Signature



# FAIR OAKS WATER DISTRICT PURCHASE AUTHORIZATION

PLEASE PRINT

CAL-CARD HOLDER NAME: \_\_\_\_\_

DATE PURCHASED: \_\_\_\_\_

WILL INVOICE - PO# \_\_\_\_\_  FINANCE TO ORDER

CHECK REQUEST \_\_\_\_\_  MISSING RECEIPT

REQUESTOR TO ORDER \_\_\_\_\_

Name of Requestor: Josh Page Date of Request: 4/24/2024

Purchase Description: Paving Restoration - E24SMPAV Date Needed By: ASAP

Vendor/Check Name: Central Valley Engineering & Asphalt, Inc Vendor Contact Name: Jamie Gruzas

Address: 216 Kenroy Lane, Roseville, CA 95678 Phone Number: 916-791-1609

Item#	Description	Quantity	Price Per Unit	Extended Price
	4901 Minnesota Ave @ Horizon; 333 ft <sup>2</sup> of Asphalt + STOP bar Striping	1	\$5,700.00	\$ 5,700.00
				\$ -
				\$ -
				\$ -
				\$ -

Subtotal: \$ 5,700.00

7.75% Tax: \_\_\_\_\_

Freight \$ -

Other \_\_\_\_\_ \$ -

Total: \$ 5,700.00

### Budget Availability (Authorized Personnel)

Approved Budget: \$ 75,000.00 Project Number: E24SMPAV

Expenses To Date: 7,796.03 Cost Category: PAVING

Committed Cost: - Completed By: JOSH PAGE

Budget Available: \$ 67,203.97 Date: 5/1/2024

### Purchase Recommendation (Supervisor)

Print Name _____	Signature _____	Date _____
<b>Purchase Authorization (Manager, Superintendent)</b>		
Nick Kepler		<input type="checkbox"/> Verbal Authorization 5/1/24
Print Name _____	Signature _____	Date _____
<b>Purchase Authorization for All Purchases (Manager)</b>		
<del>Shawn Huckaby</del> Paul Siebenschn		<input type="checkbox"/> Verbal Authorization 5/2/24
Print Name _____	Signature _____	Date _____
<b>Purchase Authorization for \$10,000 or More (General Manager)</b>		
Tom R. Gray	Signature _____	<input type="checkbox"/> Verbal Authorization
Print Name _____	Signature _____	Date _____



# TASK ORDER

**FAIR OAKS**  
WATER DISTRICT

**PROJECT:** T-Main Restoration (Pershing Ave.)

**CONTRACTOR:** Central Valley Engineering & Asphalt, Inc.

<b>TASK ORDER NO.:</b>	<u>2024 - 1</u>
<b>DATE OF TASK ORDER:</b>	<u>May 9, 2024</u>
<b>DATE of PROPOSAL:</b>	<u>May 8, 2024</u>
<b>PROJECT NO. :</b>	<u>E24RED5</u>
<b>COST CATEGORY:</b>	<u>Contractor</u>
<b>GEN CONTRACT DATE:</b>	<u>August 12, 2021</u>
<b>CONTRACT FOR:</b>	<u>General Engineering</u>

TASK ORDER NO	DESCRIPTION	COST
	Demo & Grading	\$7,735
	Concrete	\$48,090
	Asphalt	\$86,656
	Striping	\$7,150
	subtotal	\$149,631
	10% Contingency	\$14,963

**TASK ORDER TOTAL:** \$ 164,594.38

**SCHEDULED WORK DATE:** Coordinate with Nick Kepler TBD

**Accepted By:**

<b>CONTRACTOR</b>	<b>FAIR OAKS WATER DISTRICT</b> <b>DISTRICT</b>
-------------------	--

<b>Signature</b> <span style="float: right;"><b>Date</b></span>	<b>By: Paul Siebensohn, Technical Services Manager</b> <span style="float: right;"><b>Date</b></span>
---	---

<b>Print:</b>	<b>By: Tom R. Gray, General Manager</b> <span style="float: right;"><b>Date</b></span>
---------------	--



**May 20, 2024**

**Staff Report Briefing Materials**

**AGENDA ITEM III.6**

**Approval of Cal-Card Statements for the month of April 2024**

**AGENDA ITEM III.6**

REGULAR Board Meeting on May 20, 2024

---

To: Board of Directors

From: Tom R. Gray

Date: May 15, 2024

Subject: Approval of Cal-Card Statements for the month of April 2024

---

**Recommendation:**

None.

**Discussion:**

Attached you will find the Cal-Card statement summary for the period ending April 22, 2024.

**Policy Implications:**

None.

**Fiscal Impact:**

None.

**Cal-Card Statement**  
**Cal-Card Summary of Charges**  
**Closing Statement Ending April 22, 2024**

<u>Date</u>	<u>Merchant Name</u>	<u>Amount</u>	<u>Description</u>	<u>Personnel</u>
3/23/2024	Amazon	\$ 16.74	Site Maintenance	Staff
3/25/2024	Fair Oaks Chicken Run	43.72	Funded by Wellness Grant	Staff
3/26/2024	Home Depot	107.73	Tank Repair/Maintenance	Staff
3/27/2024	Amazon	25.77	Office Supplies	Staff
3/27/2024	Amazon	14.64	Office Supplies	Staff
3/27/2024	Sams Club	53.47	Maintenance Supplies	Staff
3/27/2024	Zoro Tools, Inc.	371.77	Uniforms	Staff
3/27/2024	College Oak Road Solution	165.00	Vehicle Repairs	Staff
3/27/2024	City of Sacramento	1.75	Travel	General Manager
3/27/2024	Capitol Barricade Inc.	257.97	T-Main Repair	Staff
3/27/2024	Capitol Barricade Inc.	6.26	T-Main Repair	Staff
3/28/2024	Connector Kings Corp.	720.88	Registers/AMRs	Staff
3/28/2024	Home Depot	48.08	Maintenance Supplies	Staff
3/28/2024	SMARTSIGN	(80.03)	Maintenance Supplies	Staff
3/28/2024	Amazon	11.84	Safety Equipment	Staff
3/28/2024	Amazon	8.56	Safety Equipment	Staff
3/28/2024	Amazon	22.57	Safety Equipment	Staff
3/29/2024	Capital Transmission	495.07	Vehicle Repairs	Staff
3/29/2024	Target	7.63	Office Supplies	Staff
3/29/2024	Amazon	41.41	Safety Equipment	Staff
3/30/2024	Amazon	170.58	Office Supplies	Staff
3/31/2024	Amazon	73.05	Office Supplies	Staff
4/1/2024	Mitch's Certified Classes	1,400.00	Training/Seminars	Staff
4/1/2024	Hydraulic Power Sales	62.03	Equipment Maintenance	Staff
4/1/2024	Red Wing Shoes	265.48	Safety Boots	Staff
4/2/2024	Sacramento County (EMD)	233.22	Backflow Program	Staff
4/2/2024	Sams Club	97.56	Employee Recognition	Staff
4/2/2024	Sams Club	161.46	Janitorial/Maintenance Supplies	Staff
4/2/2024	UCD Auto Glass	295.00	Vehicle Repairs	Staff
4/3/2024	Lowe's	30.13	Maintenance Supplies	General Manager
4/3/2024	New AnswerNet	171.00	Answering Services	Staff
4/4/2024	Red Wing Shoes	275.00	Safety Boots	Staff
4/4/2024	Red Wing Shoes	265.48	Safety Boots	Staff
4/5/2024	USA Blue Book	148.18	Sampling/Testing	Staff

<u>Date</u>	<u>Merchant Name</u>	<u>Amount</u>	<u>Description</u>	<u>Personnel</u>
4/5/2024	County of Sacramento/Kiefer Landfill	45.00	Site Maintenance	Staff
4/5/2024	County of Sacramento/Kiefer Landfill	45.00	Site Maintenance	Staff
4/9/2024	FedEx	55.05	Shipping Costs	Staff
4/11/2024	USPS	30.45	Postage - Corp. Yard	Staff
4/11/2024	Sacramento Fire District - Service Fee	210.30	Permits Processing Fee - Corp. Yard	General Manager
4/11/2024	Sacramento Fire District	5,324.00	Permits - Corp. Yard	General Manager
4/12/2024	Placer Equipment Rentals	169.63	Paving	Staff
4/12/2024	Brake Masters	806.74	Vehicle Repairs	Staff
4/15/2024	FedEx	54.81	Shipping Costs	Staff
4/15/2024	Chick-Fil-A	129.04	Board Meeting Meals	Staff
4/16/2024	Sams Club	68.90	Janitorial/Maintenance Supplies	Staff
4/16/2024	Sams Club	22.34	Board Meeting Meals	Staff
4/16/2024	Sams Club	53.56	Employee Recognition	Staff
4/16/2024	Sams Club	129.41	Kitchen Supplies	Staff
4/16/2024	USPS PO 0525860628	30.45	Postage - Corp. Yard	Staff
4/17/2024	Ace Hardware	96.96	Tank Repair/Maintenance	Staff
4/18/2024	Amazon	34.30	Kitchen/Office Supplies	Staff
4/18/2024	AAA Insurance	548.00	General Liability Insurance (Received \$48 Reimb.)	General Manager
4/18/2024	Handley's Western and Work Wear	(301.65)	Safety Boots	Staff
4/18/2024	Handley's Western and Work Wear	301.65	Safety Boots	Staff
4/18/2024	Handley's Western and Work Wear	275.00	Safety Boots	Staff
4/18/2024	Placer Equipment Rentals	169.63	Service Upgrades	Staff
4/19/2024	Amazon	14.64	Office Supplies	Staff
4/19/2024	Ace Hardware	4.30	Maintenance Supplies	Staff
4/21/2024	Amazon	86.35	Office Supplies	Staff
4/21/2024	Dollar Tree	38.08	Employee Recognition	Staff
		<b><u>\$ 14,430.94</u></b>		

**May 20, 2024**

**Staff Report Briefing Materials**

**AGENDA ITEM III.7**

**Accept and File Board Expense Report for the month of April 2024**

**AGENDA ITEM III.7**

REGULAR Board Meeting on May 20, 2024

---

To: Board of Directors  
From: Chi Ha-Ly  
Date: May 1, 2024  
Subject: Approval of Board Expense Report for the month of April 2024

---

**Recommendation:**

None.

**Discussion:**

Attached you will find the Board Expense Report for the month of April 2024.

**Policy Implications:**

None as a result of recommended action.

**Fiscal Impact:**

None as a result of recommended action.

Board of Directors  
Expense Reimbursement Summary  
Monthly Activity - April 2024

Name	Meeting Date	Description	Date Paid	Compensation	Reimbursed Expenses	District Expenses
<b>Dolby</b>	3/18/2024	Regular Board Meeting	4/4/2024	\$ 100.00	\$ -	\$ -
	4/15/2024	Regular Board Meeting	4/18/2024	100.00	-	-
					<b>\$ 200.00</b>	<b>\$ -</b>
<b>McRae</b>	3/18/2024	Regular Board Meeting	4/4/2024	\$ 100.00	\$ -	\$ -
	4/15/2024	Regular Board Meeting	4/18/2024	100.00	-	-
					<b>\$ 200.00</b>	<b>\$ -</b>
<b>Petersen</b>	3/18/2024	Regular Board Meeting	4/4/2024	\$ 100.00	\$ -	\$ -
	3/27/2024	SJWD Board Meeting	4/18/2024	100.00	-	-
	4/15/2024	Regular Board Meeting	4/18/2024	100.00	-	-
				<b>\$ 300.00</b>	<b>\$ -</b>	<b>\$ -</b>
<b>Sarkovich</b>	2/5/2024	Special Board Meeting	4/4/2024	\$ 100.00	\$ -	\$ -
	3/18/2024	Regular Board Meeting	4/18/2024	100.00	-	-
	4/15/2024	Regular Board Meeting	4/18/2024	100.00	-	-
				<b>\$ 300.00</b>	<b>\$ -</b>	<b>\$ -</b>

Board of Directors  
Expense Reimbursement Summary  
Monthly Activity - April 2024

**April 2024 RECAP**

Name	Meeting Month	Meetings Attended (Paid)	Month Paid	Compensation	Reimbursed Expenses	District Expenses
Dolby	March/April	2	April	\$ 200.00	\$ -	\$ -
Marx		0		-	-	-
McRae	March/April	2	April	200.00	-	-
Petersen	March/April	3	April	300.00	-	-
Sarkovich	February/March/April	<u>3</u>	April	300.00	-	-
<b>TOTAL</b>		10		<b>\$ 1,000.00</b>	<b>\$ -</b>	<b>\$ -</b>

**Year-to-Date RECAP**

Name	Meetings Attended (Paid)	Compensation	Reimbursed Expenses	District Expenses
Dolby	7	\$ 700.00	\$ -	\$ -
Marx	5	500.00	-	-
McRae	6	600.00	-	-
Petersen	8	800.00	-	-
Sarkovich	<u>6</u>	600.00	-	-
<b>TOTAL</b>	32	<b>\$ 3,200.00</b>	<b>\$ -</b>	<b>\$ -</b>



**May 20, 2024**

**Staff Report Briefing Materials**

**AGENDA ITEM V.1**

**Discussion and possible action on the selection of a consultant to provide professional design services for the Northridge Well Project**

---

**AGENDA ITEM V.1**

REGULAR Board Meeting May 20, 2024

---

To: Board of Directors  
From: Tom R. Gray  
Date: May 16, 2024  
Subject: Discussion and possible action on the selection of a consultant to provide professional design services for the Northridge Well Project

---

**Recommendation:**

Direct the General Manager to negotiate a fair and reasonable agreement for providing professional services to drill and equip a new groundwater well at the existing Northridge Well site with KASL Consulting Engineers for FOWD Board approval.

**Discussion:**

The Healthy Rivers and Landscapes Alternative is the current iteration of the effort started in 2018 that was dubbed the “Voluntary Agreements.” The Newsom administration convened key water districts, state agencies, and other interested parties to work out this alternative method to meet Bay-Delta Plan goals that did not rely wholly on the State Water Board staff-generated concept of extreme unimpaired flow requirements. As part of this program the Fair Oaks Water District had an opportunity to obtain funding for a new groundwater production facility.

At a public Fair Oaks Water District (FOWD) meeting held on August 17, 2023 the FOWD Board of Directors unanimously voted to approve a Project Agreement with the Sacramento Regional Water Authority that included funding for the Northridge Groundwater Well Project. In accordance with the general terms of the agreement, and exchange for the funding, the FOWD will complete a new groundwater well at the existing Northridge Well property and make annually available 1,374 AF of water in three years over an eight-year period. In exchange the FOWD will receive project cost reimbursement of up to \$2,470,000. FOWD staff will be responsible for coordination commitments such as technical team meetings, flow accounting, and annual collaboration to provide flow recommendations and reviews.

Given external factors outside of the control of the FOWD, the project was placed on hold for a few months.

At a public FOWD Board of Directors meeting held on March 18, 2024 the Board directed staff to prepare a Request for Proposal (RFP) to provide professional design services to redrill and equip a new groundwater well at the existing Northridge Well Site in Fair Oaks.

---

Design and Construction Management Services:

- A. March 29, 2024 - FOWD staff completed the RFP - a copy of the RFP is attached.
- B. April 1, 2024 - FOWD posted the RFP for response from qualified consultants.
- C. April 30, 2024 - Responses from qualified consultants were due at the FOWD office.
- D. Three consulting firms responded to the solicitation:
  - Luhdorff & Scalmanini Consulting Engineering (L&S)
  - Kasl Consulting Engineering (KASL)
  - Mark Carey Engineering (MCE)

All three firms met the minimum requirements for submittal of a response to the RFP, therefore all three responses were evaluated in accordance with the Section 8 of the RFP.

E. Analysis of Proposals

1. Project Team Qualifications & Experience (25 Points)

MCE has experienced personnel, qualified for design and inspection of pumping plants. The senior hydrogeologist scheduled to lead the design of the well is qualified and has designed many groundwater wells. The project design team for the well equipping lacked project experience when compared to the other two responses.

L&S and KASL teams provided responses indicating that their teams have extensive experience in all aspects of groundwater production.

KASL references were clear, relevant, easy to contact, and local. L&S references were detailed but included one local contact. MCE references were limited to one actual well project.

- KASL            24.0 Points
- L&S            25.0 Points
- MCE            19.0 Points

2. Project Approach (35 Points)

The three proposals clearly demonstrate that their team: understand the project requirements and key issues, will maintain compliance with regulatory permits, and have local understanding of resources and agencies.

L&S provided good detail on their project approach. Their proposal varied from the RFP by sole sourcing the well drilling to a L&S subcontractor. While we invited alternative approaches to the work, we expected all to respond directly to the RFP and then provide an alternative approach for FOWD consideration. Though highly qualified, the review team was concerned that L&S may struggle in responding to FOWD recommendations relative to project details.

MCE responded to the RFP well and provided alternative approaches after responding directly to the RFP. Overall, their proposal was good. Detailed review of their proposal indicated that their team was the least experienced of the responding teams.

KASL provided good detail on their project approach. Their team's response was in accordance with the RFP. Based on recent experience, they highlighted "lead time" issues that could impact project delivery and offered solutions. They also demonstrated a positive record with recent projects of similar scope.

- KASL 32.5 Points
- L&S 31.0 Points
- MCE 29.0 Points

### 3. Ability to Meet Schedule (25 Points)

The FOWD recognizes that the project delivery date listed in the RFP is aggressive and will require multitasking during design and construction. Both MCE and KASL did a good job of acknowledging this in the responses provided by their teams – while MCE seemed more concerned that the aggressive schedule could be met.

- KASL 24.0 Points
- L&S 23.0 Points
- MCE 23.0 Points

### 4. Resource Allocation (15 Points)

All three of the responding teams have experienced qualified engineers and hydrogeologists for design and inspection of water supply facilities. MCE and KASL are located near the project site, while L&S is located slightly further away in Woodland. The L&S response leaned more towards virtual interaction than did the responses from MCE and KASL. Concern was that the FOWD Project may be competing for resources internally at L&S.

- KASL 13.5 Points
- L&S 13.0 Points
- MCE 12.5 Points

Final Scoring of Proposals			
Item	KASL	L&S	MCE
Experience of Team (25 Points)	24.0	25.0	19.0
Resource Allocation (15 Points)	13.5	13.0	12.5
Work Approach (35 Points)	32.5	31.0	29.0
Schedule (25 Points)	24.0	23.0	23.0
Total	94	92	83.5

The KASL proposal demonstrated that they: understand the project requirements and key issues, will maintain compliance with regulatory permits, have local understanding of resources and agencies, and understand the aggressive project delivery date.

Items of Note:

Professional services are unique by their nature; therefore, they are not subject to competitive bidding. When procuring specialized services, the District is principally dependent upon the skill, integrity, judgment, and ability of the service provider rather than the dollar cost of the direct labor and material. Pursuant to Section 37103 of the California Government Code, the FOWD may contract with any specially trained and experienced person, firm, or corporation for special services and advice in financial, economic, accounting, engineering, legal or administrative matters. It may pay such compensation to these experts as it deems proper. When contracting for architectural, landscape architectural, engineering, environmental, land surveying, and construction project management services, requirements of Sections 4525 through 4529.5 of the California Government Code must be met.

*FOWD Policy 5110 Section 5.13.1.* Request for proposal or qualification may be used in lieu of the bid process when selection is based on qualification, quality, experience, design, past performance, or work approach.

*California Government Code Section 37103.* The legislative body may contract with any specially trained and experienced person, firm, or corporation for special services and advice in financial, economic, accounting, engineering, legal, or administrative matters. It may pay such compensation to these experts as it deems proper.

**Policy Implications:**

None because of the recommended action.

**Fiscal Impact:**

To be determined.

# **Fair Oaks Water District**

## **Request for Proposal**

Provide professional services required to redrill and equip a new groundwater well at the existing Northridge Well Site in Fair Oaks.



**FAIR OAKS  
WATER DISTRICT**

Prepared by:  
FOWD Staff  
10326 Fair Oaks Boulevard  
Fair Oaks, CA 95628  
FOWD Project No. C24WTNWRD

April 2024

**General Information**

Project Location: 8251 Kaula Drive. in Fair Oaks, CA 95628

- Attachments:           Exhibit "A" – Northridge Well site  
                                  Exhibit "B" – Existing Northridge Well "As-Built" Drawings  
                                  Exhibit "C" – FOWD Professional Services Agreement

**1.0 RFP Schedule**

- |                            |   |
|----------------------------|---|
| April 1, 2024              | Posting for Proposals                         |
| April 15, 2024, at 3:00 PM | Proposal Inquires Due Date                    |
| April 30, 2024, at 3:00 PM | Proposals Must Be Received at the FOWD Office |
| May 7, 2024                | Interviews if needed                          |
| May 20, 2024               | FOWD Board Approval                           |

**2.0 Contact Person and Mailing Address**

Inquiries about this request for proposal shall be submitted in writing and directed to:

Paul Siebensohn  
Technical Services Manager  
Phone: (916) 967-5723  
E-Mail: [psiebensohn@fowd.com](mailto:psiebensohn@fowd.com)

Mailing Address:

Fair Oaks Water District  
Attn: Paul Siebensohn  
10326 Fairs Oaks Boulevard  
Fair Oaks, CA 95628

**3.0 Minimum Consultant Qualifications**

The intent of this Request for Proposal is to select a professional consulting firm to develop a set of construction drawings, construction specifications, bid documents, and to provide construction management support required to successfully redrill and equip a new groundwater well at the existing Northridge Groundwater Well site.

Minimum Consultant Firm qualifications are listed below:

- 3.1 The Consultant must be engaged in the business of potable water well development and be experienced in planning, permitting, design, and construction management of potable water wells – having completed at least two (2) similar projects.
- 3.2 The Consultant must employ only a competent workforce for the execution of the work and all work must be performed under the direct supervision of one named Project Manager that is either a Professional Engineer or Professional Geologist.
- 3.3 Consultant must maintain in full force and effect all insurance requirements required to work with the Fair Oaks Water District.
- 3.4 Consultant must not have a conflict of interest as defined by State law and FOWD policy. Consultant agrees to make a disclosure in compliance with the law and District policy if, at any time after the execution of an agreement to perform professional services, a conflict of interest may occur.

#### **4.0 Existing Water Supply Facility**

- 4.1 The existing Northridge Well is located at 8251 Kaula Drive in Fair Oaks. The existing pumping unit has a design capacity of 1,100 gpm and is equipped with a 150-horsepower submersible well pump. The existing well was reverse mud-rotary drilled in 1991 with a 14-inch steel casing installed to a depth of 550 feet.
- 4.2 All available site data, well data, and water quality data for the existing Northridge Well will be provided to selected consultant.

#### **5.0 District's Objectives and Expectations**

- 5.1 The District's main objectives are:
  - ***Meet the December 31, 2025 deadline to have the project completed and accepted as a water supply source in the FOWD's Water Supply Permit.***
  - Increase water supply reliability for FOWD customers during period of drought and low availability of surface water supply.
  - Maximize production capacity without compromising water quality from the new well under normal operating conditions.
  - Meet all applicable US EPA and the State Division of Drinking Water water quality standards for groundwater wells.



- Maximize specific yield and reduce operation and maintenance cost of the new well under normal operating conditions.
- Utilize the best available technology in construction of the potable groundwater well.
- When deemed reasonable, utilize available existing infrastructure to minimize construction cost.
- Comply with all necessary State and County regulations for drilling of the new well and abandonment of the existing well.

## **6.0 Scope of Work**

The following minimum scope of work was developed for the project and all proposals must include listed deliverables for each listed task.

As a proposal addendum, it is requested all proposals include additional tasks that the consultant deems important for the successful completion of the project if not listed.

### **6.1 Task 1 - Preliminary Work and Site Evaluation**

- Complete site survey and general assessment.
- Prepare a Drinking Water Source Assessment Plan (DWSAP) and submit to it to the Division of Drinking Water (DDW). Address any comments to gain DDW approval.
- Coordinate completion of necessary Water Quality sampling.
- Prepare a Low Threat NPDES permit application and process it through regulatory agency for approval.
- Abandon Existing well.

### **6.2 Task 2 - Pilot Hole Construction and Initial Geophysical Surveys**

- Review existing well's drilling log and information.
- Prepare a set of construction specifications for completion of an 8-inch pilot hole at the proposed new well location.
- Provide Fair Oaks Water District with the list of qualified well drilling contractors.

- Based on the geophysical surveys, complete and present to the District a basis for design of the new well in a written Feasibility Memorandum outlining the potential yield, water quality, construction details and cost estimate for a new groundwater well at this location. Consideration should be given to ensuring that the new well will meet all drinking water standards without treatment and analyze impacts of potential treatment implementation if recommended.

### 6.3 Task 3 – New Well Design and Construction

- Based on the Feasibility Memorandum developed in task 2, prepare a complete a bid package consisting of a set of construction specifications and plans for drilling a new groundwater well at the site.
- Complete required environmental documentation.
- Prepare topographic survey.
- Provide FOWD with the list of qualified well drilling contractors.
- Post and distribute bid package.
- Assist the District with Bid Addendums and Requests for Information from qualified contractors.
- Upon receiving Bids, provide District with the written recommendations for awarding construction contract.
- Provide full construction and engineering project management during the construction of the new well through completion. This shall at a minimum include pre-construction and weekly progress meetings, submittal review, site monitoring, drill cutting and soils sample logging, well development, water quality monitoring, and review / approval of invoices for payment by the FOWD.
- Provide FOWD with a Well Completion Report that summarizes the construction and testing of the new well. Report must include pilot hole logs, geophysical logs, permitting, construction methods and materials, as-built details, results of testing and recommendations for long-term pumping rate of the well. This report will be used to deign equipment for the new well.

### 6.4 Task 4 - New Well **Equipping** Design and Construction

- Develop a preliminary site plan for FOWD approval.

- Handle utility coordination.
- Obtain required permits and permissions.
- Provide construction staking.
- Develop a complete set of plans and specifications that at a minimum include the following:
  - Cover Sheet
  - Grading and Drainage Plan (must include existing and proposed elevations extending 25 feet beyond the property lines)
  - Site Development Plan
  - Architectural Plans and Details (if required)
  - Civil Plans and Details
  - Mechanical Plans and Details
  - Electrical Plans and Details
  - Structural Plans and Details (if required)
  - Instrumentation and Controls (SCADA) and Integration Plan
- Provide an operation memorandum.
- Design Review Meetings
  - 50% Design Review – Prepare for, conduct, and document a 50% design review meeting to include civil, architectural, mechanical, electrical, and instrumentation designs; specifications outline; SMUD application and submittal.
  - 95% Design Review – Prepare for, conduct, and document a 95% design review meeting to include all drawings, all technical and construction specifications, engineering opinion of the probable construction cost, and preliminary operations plan for groundwater well.
- Provide FOWD with the list of qualified well equipping contractors.

- Post and distribute bid package.
- Assist FOWD with bid addendums and requests for information from qualified contractors.
- Upon receiving bids, provide FOWD with written recommendations for awarding construction contract.
- Construction Management and Inspection - The Consultant is to provide quality construction management services for successful completion of the project on schedule and within budget. The following specific tasks will be completed by the Consultant:
  - Attend pre-construction meeting, review construction schedule.
  - Provide Notice to Proceed
  - Review Contractor submittals for conformance to the design drawings and specifications.
  - Review and respond to Contractor's Requests for Information (RFI).
  - Issue field memorandums and clarifications as required.
  - Review Contractor change orders and provide recommendations to District staff.
  - Review Contractor progress payments and provide recommendations to District staff.
  - Assist in resolving conflicts caused by discrepancies in contract documents.
  - Assist in start-up and commissioning operations, attend contractor walkthroughs; final inspections and testing.
  - Prepare and provided record drawings depicting as-built conditions in AutoCAD (latest version) and pdf.
  - Provide Notice of Completion.
  - Provide an Operation and Maintenance Manual in Word and pdf formats.

## 7.0 How to Submit Proposals

Proposal shall be submitted in a sealed envelope, clearly marked on the outside with the Project Name **Northridge Well Replacement – Design**.

Respondents must submit one (1) unbound and two (2) bound copies of the response with all the information requested in this document. Respondents must submit all information related to fees in a separate sealed envelope included in the package. Proposals should be prepared simply and economically, by providing a straightforward, concise description of the proposer's capabilities related to specified services. Proposals should not include any information not specifically identified or specified as a required response. FOWD requests that proposals be limited to 20 pages (not counting resumes and example plan sets) submitted in the format outlined below.

- Cover Letter indicating RFP title, name of firm, local firm address, local firm phone number and contact person with an email address – 1 page.
- Table of Contents – 1 page.
- Brief description of the firm and qualifications for completing the project – 2 pages.
- Based on the scope of services outlined in the RFP, an overview of project understanding and a high-level plan for completing the project. This section must also include a proposed schedule for completing the project – including milestones for completion of each of four listed project tasks. If different, please provide an alternate approach for meeting the December 31, 2025 through construction project completion date – 6 pages.
- Information on the firms Project Team for the term the contract – 4 pages.
  - Organizational structure of firm.
  - Name of the point-of-contact in the firm that will be responsible for ALL Project issues – Project Manager. This is the person that will have direct and continued responsibility for the services provided to the FOWD. This person will be FOWD's first point-of-contact and will handle day-to-day activities through to the Project's completion.
  - List key Project personnel and project role.
  - Experience and resumes of key Project personnel.
  - Identification of subconsultants, if applicable.

- Other pertinent information.
- Project References – provide public agency project references including client contact information – providing improvement plans (half-size) for **one (1)** of the referenced projects – 3 pages.
- ***In a separate sealed envelope***, provide a project fee proposal broken down by the four tasks listed in the RFP. Include fee estimates for all sub-consultants and vendors with supporting information. This initial fee estimate will be used to finalize the Professional Services Agreement developed between the selected consultant and FOWD. Please also include the following in the project fee proposal:
  - Hourly rate schedule for each person that will be assigned to the Project or bill to the project, including all sub-consultants.
  - Provide mark-up by percentage for reimbursable expenses and sub-consultants.
  - Provide list of typical reimbursable expenses.
  - Please note that the project fee proposal does not have a suggested page limit and that pages included in the project fee proposal do not count in the suggested total page limit of 20 pages.

## 9.0 Proposal Selection

All proposals must be received no later than proposal due date. ***Late proposals will not be considered.***

- Cost of preparation of proposals will be borne by the proposer.
- In submittal of a proposal, proposer provides the FOWD with the right to contact all references listed in the proposal and to investigate all information listed in the proposals.
- This request does not constitute an offer of employment or to contract for services.
- The FOWD reserves the right to reject any or all proposals, wholly or in part, received by reason of this request.
- All proposals submitted shall become FOWD property.

- All proposals shall remain firm for sixty (60) days following the closing date for receipt of proposals.
- The FOWD reserves the right to award the contract to the firm who represents the proposal which in the judgment of the FOWD best accomplishes the desired results and shall include but not be limited to a consideration of the professional service fee.
- Selection will be made based on the proposals submitted.

### **8.0 Selection of Consultant**

FOWD is seeking an engineering firm that offers qualifications and competence that best meets the needs of the District. FOWD, to the best of its ability, will utilize the Qualifications-Based Selection guidelines listed in the table below in evaluating the proposals.

The following will be used by the selection committee for the use of ranking proposals, based on how fully each proposal meets the requirements of this RFP.	
Cover Letter	Pass / Fail
Active Required Professional License	Pass / Fail
Qualifications & Experience of Team	25 points out of 100 points
Resource Allocation	15 points out of 100 points
Work Approach	35 points out of 100 points
Ability to Meet Schedule	25 points out of 100 points
Notes:	
1. If interviews are conducted, the proposers selected will be required to physically attend interviews conducted at the FOWD office.	
2. If interviews are conducted, the FOWD will not interview more than the top three ranking proposers.	

A review panel will rank the proposals based upon the aforementioned criteria and make a selection or may select proposers to interview.

After a firm is selected, the District will negotiate with the firm to determine a final scope of work and fee proposal for the final Professional Services Agreement.

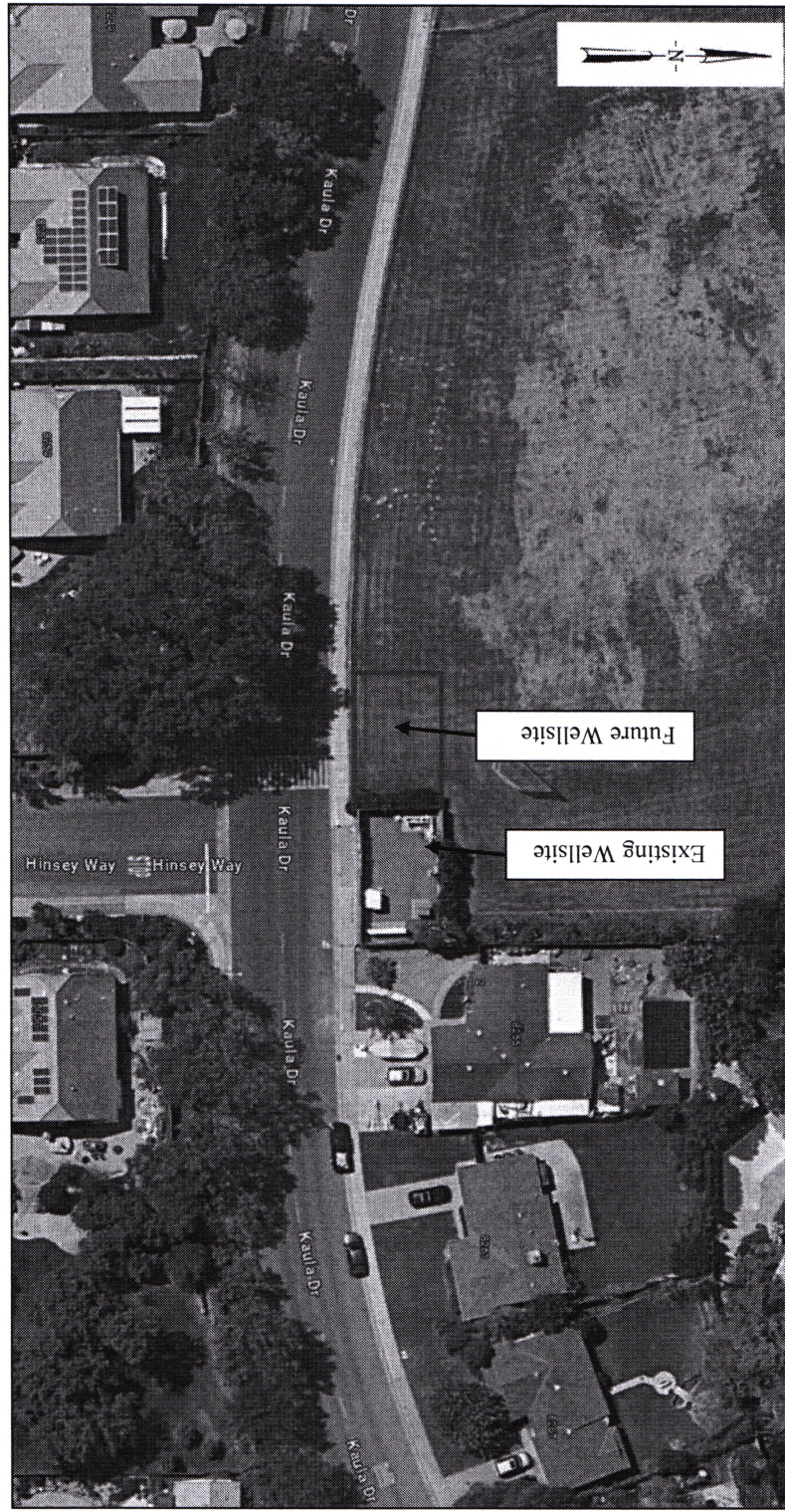

Exhibit "A"



**May 20, 2024**

**Staff Report Briefing Materials**

**AGENDA ITEM V.2**

**Discussion and possible action on the New York Water Main Replacement Project**

---

**AGENDA ITEM V.2**

REGULAR Board Meeting on May 20, 2024

---

To: Board of Directors  
From: Tom R. Gray  
Date: May 15, 2024  
Subject: Discussion and possible action on the New York Water Main Replacement Project

---

**Recommendation:**

Approve the attached bid package for Phase I of the New York Main Replacement Project and direct the General Manager to obtain bids for the construction in accordance with the included schedule.

**Discussion:**

At the April 15, 2024, public meeting of the Fair Oaks Water District (FOWD) Board of Directors, the FOWD Board directed staff to proceed with development of a bid package for the construction of Phase I of the New York Main Replacement Project. This phase of the project includes the replacement of 1,810 feet of “at risk” steel water main from north of Lemon Street to Orange Avenue.

All plans and specifications for this project were developed by FOWD staff.

The bid package developed for this project is attached for your review and comment.

**Policy Implications:**

None.

**Fiscal Impact:**

Estimated funding for the New York Main Replacement Project was included in the FOWD Board approved 2024 budget.

**Fair Oaks Water District**  
**Request for Bid**  
**New York Avenue – Phase I**



**(FOWD PROJECT #C24TDNYASW)**

Prepared by:  
FOWD Staff  
10326 Fair Oaks Boulevard  
Fair Oaks, CA 95628

May 2024

## **List of Items Included in This Bid Request:**

	<b>Page</b>
<b>1. BID FORM</b>	<b>03</b>
<b>2. EXHIBIT A – GENERAL TERMS AND CONDITIONS</b>	<b>12</b>
<b>3. EXHIBIT B – WATER MAIN REPLACEMENT PLAN ON NEW YORK AVENUE (PHASE I)</b>	<b>29</b>

# **BID FORM**

## **Background**

The New York Avenue steel water main to be replaced was installed in the early 1950s and cement lined in the early 1980s. The main is over 70 years old, experienced several leaks in the past years, and has observed loss of pipe integrity due to corrosion.

## **Project**

This project provides for the installation of 12-inch class 350 ductile iron pipe from north of Lemon Street on the south end to Orange Avenue on the north end, with tie-ins at each intersection: a total estimated lay length of 1,810 ft. The FOWD has pre-purchased 18' sections of 12-inch class 350 ductile iron pipe, tyton joint, which is available to the contractor for this project. Installation of 12-inch ductile iron pipe will allow for replacement of 12-inch aged steel main on New York Ave., to be abandoned in place per FOWD Standard. A second phase is planned from Monal Ct. to Lemon St., to be bid and constructed at a later time.

## **Note:**

The Fair Oaks Water District (FOWD) reserves the right to reject any or all bids, to waive any informality in any bid, and to determine which bid, in the judgment of the FOWD, is the lowest responsive bid of a responsible bidder.

**Project Location:** New York Ave. from north of Lemon St. to Orange Ave., in Fair Oaks, CA

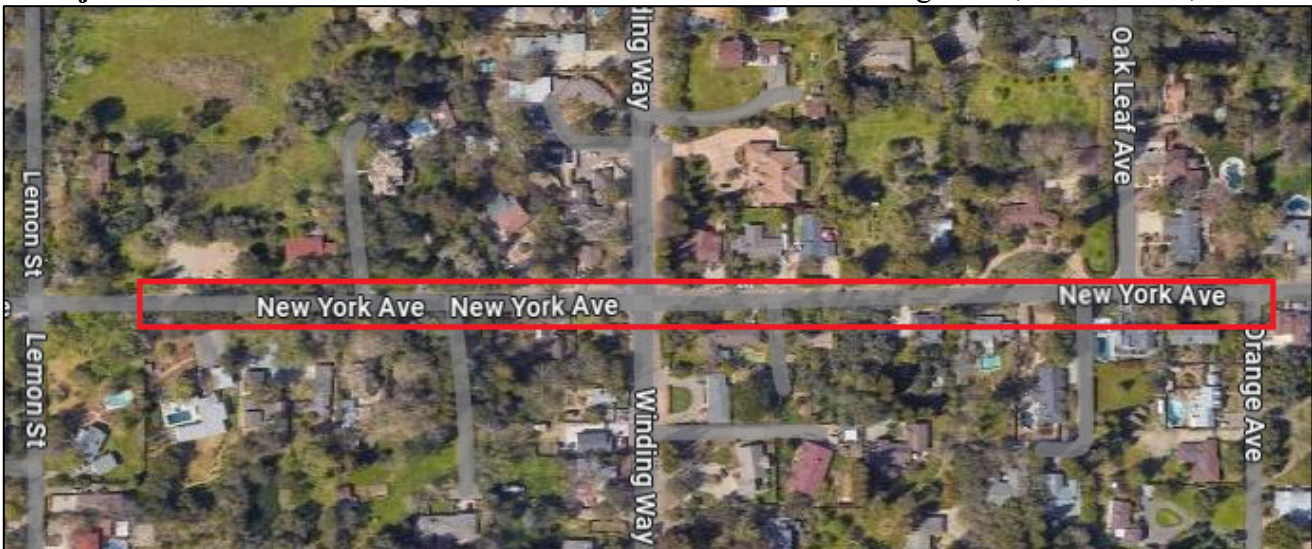

## **Submit Bid To:**

Fair Oaks Water District  
Attn.: Paul Siebensohn – Technical Services Manager  
10326 Fair Oaks Blvd.  
Fair Oaks, CA 95628

**Bid Inquires Due Date:** 12:00 PM Wednesday, June 5, 2024

**Bid Due Date:** 12:00 PM Wednesday, June 12, 2024

**Project Title:**                    **New York Avenue - Phase I**

**Proposal Submittal and Selection**

1. All proposals must be received no later than Bid due date and time. **Late proposals will not be considered.**
2. Cost of preparation of proposals will be borne by the proposer.
3. This request does not constitute an offer of employment or to contract for services.
4. The FOWD reserves the right to reject any or all proposals, wholly or in part, received by reason of this request.
5. All proposals submitted shall become FOWD property.
6. All proposals shall remain firm for a minimum of sixty (60) days following the closing date for receipt of proposals.
7. Bid bond must accompany submitted bid.
8. The FOWD reserves the right to award the contract to the firm who represents the proposal which in the judgment of the FOWD best accomplishes the desired results and shall include but not be limited to a consideration of the fee.

**How to Submit Proposals**

Proposal shall be submitted in a sealed envelope, clearly marked on the outside with the Project Name (**New York Avenue Phase I**) and project number (**#C24TDNYASW**). All proposals must be received no later than 12:00 p.m. on **June 12, 2024**. The FOWD office is open to public Monday-Friday, 8AM – 4:30PM and a mail drop slot is available at front entrance of office.

**Bid Opening:** There will be a public bid opening conducted via teleconference immediately following the bid due date and time. Bidders' representatives shall use the following logon information for the teleconferencing:

**Phone: 916-844-3159**  
**Conference ID: 208640**

**I. Bid:**

Pursuant to your Notice for the above referenced project, and in accordance with the approved plans for the project, the following bid for said entire project #C24TDNYASW is submitted by the firm indicated in Section VII of this bid form:

## PHASE I

### New York Avenue – From North of Lemon Street to Orange Avenue

Item No.	Description	Estimated Quantity	Unit	Unit Price	Extended Price
<b>Water Main and water services installation</b>					
A1	*Installation of 12" ductile iron pipe (Cl.350 TJ) Due to possible conflict with existing utilities, water facilities may need to be installed deeper than typical 36" depth in various locations.	1,810	LF		
A2	Installation of 8" ductile iron pipe (Cl.350)	55	EA		
A3	Installation of 6" fire hydrant	4	EA		
A4	Installation of 1" water service, reconnecting to existing meter setter	19	EA		
A5	Installation of 1.5" water service, reconnecting to existing meter setter	3	EA		
A6	Installation of new 2" water service to New York Well Site - complete service	1	EA		
A7	Installation of 2" water service and reconnection to existing meter setter	1	EA		
A8	Installation of 1" air and vacuum release valve (AVRV)	2	EA		
A9	POC installation station 23+21	1	LS		
A10	POC installation station 30+16	1	LS		
A11	POC installation station 30+74	1	LS		
A12	POC installation station 32+69	1	LS		
A13	Potholing at crossings with existing utilities	1	LS		
A14	Disinfection, flushing, and pressure testing, in accordance with the FOWD standards	1	LS		
A15	Abandonment/removal and disposal of existing water facilities as called on the plan and as needed per site condition	1	LS		
A16	Traffic control plan	1	LS		
A17	Erosion and sediment control as needed and as per Sacramento County requirements	1	LS		
A18	Retirement of Fire Hydrants	4	LS		
<b>Subtotal Items A1 - A18</b>			<b>\$</b>	_____	

\*FOWD pre-purchased 12-inch class 350 DIP to be available for this project. Contractor must provide restraining gaskets. Provide the unit price for installation per linear foot.

<b>Paving and Street Restoration **</b>					
P1	Pavement and asphalt restoration per Sac. County specifications and standards	22,000	SF		
P2	Slurry seal per Sac. County specifications and standards	22,000	SF		
P3	Street marking restoration per Sacramento County requirements	1	LS		
P4	Sidewalk, curb and gutter, and driveway replacement per Sac. County specifications and standards	100	SF		
<b>Subtotal Items P1-P4</b>				<b>\$ _____</b>	

\*\* The paving and street restoration quantities are approximate. The final quantity will be determined upon completion of water main installation and coordination with the County Inspector. Any additional costs will be per bid unit cost provided. Street restoration may include only asphalt paving or a combination of both asphalt and slurry seal.

**TOTAL BID AMOUNT FOR PROJECT**                      **\$ \_\_\_\_\_**



## NOTES:

1. The total bid amount for project will be the base for award. Bid prices are required for all bid items.
2. In the event of a discrepancy between the estimated quantity and actual work completed, the unit price will govern and extend to quantity of work completed. Any extra work required must be approved as a Change Order in accordance with FOWD General Conditions prior to completion.
3. Bidders are required to inspect the site of work to satisfy themselves, by personal examination or by such other means as they prefer, of the location and scope of the proposed work, and of the actual conditions of and at the site of the work and of any obstacles or items that may require temporary relocation or removal.
4. If during the course of a bidder's examination a bidder finds facts or conditions that appear to be in a conflict with the plans provided to bidder, the bidder shall provide a written request for clarification to the project manager so that any conflict can be resolved during the bid process by addendum. Requests for clarification are to be submitted to Paul Siebensohn at [psiebensohn@fowd.com](mailto:psiebensohn@fowd.com) no later than 12:00 pm on Wednesday, June 5, 2024.
5. The completion time for the project is eighty-four (84) calendar days after issuance of "Notice to Proceed" by the FOWD. If contractor is delayed in the performance or progress of work due to force majeure, or other causes beyond the Contractor's control, those proposed delays would require approval in writing by the FOWD and tracked as "days added to contract."
6. The project must begin at the south end and work northward to avoid another FOWD project at 4267 New York Avenue.
7. Contractor shall make all efforts to maintain water service to customers with minimal disruption.
8. Contractor shall neatly cut and remove existing pavement. Restoration of pavement and road marking shall be completed as per the Sacramento County requirements. The FOWD does not provide geotechnical service and it is the Contractor's responsibility to meet the Sac. County requirement for compaction testing and geotechnical reports. Refer to the FOWD Std-9 for trench section detail. No native backfill is allowed.
9. Request for USA and preparation for USA implementation, surveying and staking to be completed by the Contractor.
10. The FOWD provides construction water. Contractor must rent a construction meter equipped with certified backflow device from the FOWD. Construction meter will require a \$4,000 refundable deposit. (<https://www.fowd.com/development-forms>)
11. The contractor must prepare traffic control plans and approval from the Sacramento County Department of Transportation prior to start of construction. The Contractor is responsible for project site safety and for public safety including traffic control, 24 hours/day for all days from the start date of mobilization through the notice of final completion.

12. On alignment of piping, deflection or pull at each joint shall not exceed seventy-five percent (75%) of the maximum amount recommended by the pipe manufacturer for the given type and size joint. Fittings must all be mechanical joint 350 psi working pressure or greater. Ductile iron pipeline gaskets must be Field Lok 350, or equal, per AWWA C111.
13. The Contractor shall be responsible for potholing of utilities as needed and provide construction staking to locate the exact location and elevations for tie-ins with water facilities and to avoid any conflicts.
14. Any affected utilities shall be restored to preconstruction conditions, or better, at the sole expense of the Contractor.
15. Existing meters and meter setters to be reconnected per FOWD standard specifications.
16. FOWD will provide shutdowns of existing water mains and assistance with necessary notification to customers required to complete project. All shutdowns must be completed by the FOWD, or under supervision of an authorized FOWD staff, in coordination with FOWD inspector.
17. FOWD will inspect construction of water system improvements proposed under this agreement. FOWD inspection does not waive any of the Contractor's responsibilities under this contract.
18. Contractor shall comply with the requirements of Sacramento County Encroachment Permit for the project.
19. Contractor is solely responsible for disinfection and handling of disinfection discharge. FOWD will provide bacteriological sampling in coordination with contractor and FOWD inspector.
20. A bid bond shall be provided along with the bid proposal. Prior to fully executing the contract, selected Contractor shall provide performance bond and payment bond effective from the date the contract is fully executed until the FOWD accepts the project to be completed by the Contractor. Additionally, prior to full execution of the contract, selected Contractor shall provide maintenance bond and guarantee for the project that are effective for a period of one (1) year from the date the project is accepted by the FOWD. Bonds mentioned above shall be in the sum of not less than one hundred percent (100%) of the bid/contract amount, including approved change orders. More information about the bonds mentioned above and guarantee are available in the FOWD Standard Specification and General Conditions.

## **II. ADDENDA:**

Acknowledgment of addenda shall be incorporated as part of the bid submittal.

## **III. BID GUARANTY:**

Bid security must be a bidder's bond, a certified check or cashier's check payable to FOWD.

## **IV. AFFIDAVIT OF NON-COLLUSION:**

The bidders swears and deposes that they are the party making the foregoing bid, that the bid

is not made in the interest of, or on behalf of, any undisclosed person, partnership, association, organization, or corporation; that the bid is genuine and not collusive or sham; that the bidder is not directly or indirectly induced or solicited any other bidder to put in a false or sham bid, and has not directly or indirectly colluded, conspired, or agreed with any other bidder or anyone else to put a sham bid; that the bidder has not in any manner, directly or indirectly, sought by agreement, communication, or conference with anyone to fix the bid price of the bidder or any other bidder, or to fix any overhead, profit or cost element of the bid price; that all statements contained in the bid price are true.

**V. SUBCONTRACTOR LISTING:**

In accordance with the California Public Contract Code, Division 2, Part 1, Chapter 4, Section 4100 and following, the subcontractors listed on the Attachment A of this Bid Form will perform the indicated work on this project. Attachment A is hereby incorporated into and made a part of this bid.

**VI. TYPE OF BUSINESS:**

- CORPORATION: STATE OF CORPORATION
- PARTNERSHIP
- JOINT VENTURE
- PRIVATE INDIVIDUAL
- INDIVIDUAL DOING BUSINESS UNDER A FIRM NAME

**VII. FIRM:**

**NAME:** \_\_\_\_\_

**CONTACT:** \_\_\_\_\_

**ADDRESS:** \_\_\_\_\_

**TELEPHONE:** \_\_\_\_\_

**EMAIL:** \_\_\_\_\_

**CALIFORNIA CONTRACTOR'S LICENSE NUMBER:** \_\_\_\_\_

**CONTRACTOR'S LICENSE EXPIRATION DATE:** \_\_\_\_\_

**CONTRACTOR LICENSE CLASSIFICATION:** \_\_\_\_\_

I hereby certify under penalty of perjury that the above statements are true.

Bid and certification submitted by: \_\_\_\_\_

Signature: \_\_\_\_\_  
Authorized Representative

Title: \_\_\_\_\_





# **EXHIBIT A**

## **GENERAL TERMS AND CONDITIONS**

## GENERAL TERMS & CONDITIONS

### CONTRACT FORMATION

Contractor's quotation or proposal is deemed a firm offer and the final signing of this contract by all parties constitutes invocation of all items within the contract and is legally binding.

### Section 1 – RESPONSIBLE PARTIES/DEFINITIONS

**District:** Whenever the word "District" or alternatively, "FOWD" is used in these General Conditions, it shall be understood to mean the Fair Oaks Water District and acting by and through its Authorized FOWD Representative.

Contractor shall not accept direction or orders from any person other than the General Manager or the person(s) whose name(s) is (are) inserted on the CONTRACT as "other authorized representative(s)."

**Contractor:** The word "Contractor" shall be understood to mean a Contractor (the contracting company) who has a current California State Contractor's License of appropriate class to do the work for which it is contracted to do as defined in the *California Contractor's License Law and Reference Book*; has, when applicable, a current business licenses to perform the work from the local jurisdiction where the work is to be performed; has been approved by the District; and is employed through the District's General Contract documents to complete the scope of work contained therein in accordance with the District's "STANDARD SPECIFICATIONS & STANDARD DRAWINGS" and "EQUIVALENT MATERIALS LIST" for pipeline work, the Contractor shall have a Class A or C34 California Contractor's License.

**County:** Whenever the word "County" is used in these General Conditions, it shall be understood to mean the County of Sacramento.

### Section 2 - CONTRACT DOCUMENTS

**Contract Defined:** Wherever used herein, the term "Contract" shall mean the Fair Oaks Water District "General Contract", these General Conditions, the appropriate form of bid document, and any other documents incorporated into the Contract by reference. All of the forgoing documents shall together form the agreement between Contractor and the District, and a reference to any of them shall be deemed to include the entire Contract which shall be read as a whole.

The Contract, which may be supplemented from time to time with additional accepted bids and/or revised contract documents, represents the entire and integrated agreement of the parties and supersedes all prior negotiations, agreements, and understandings.

Work called for in any one Contract Document and not mentioned in another is to be performed and executed as if mentioned in all Contract Documents. The titles and headings contained herein and in said documents are solely to facilitate reference to various provisions of the Contract Documents and in no way affect or limit the interpretations of the provisions to which they refer.

**Conflicts:** In the event of a conflict between the terms and conditions as set forth in this Contract and the terms and conditions set forth in other Contract Documents, the terms and conditions set forth in this Contract shall prevail.

**Plans and General Conditions:** Where conflicts exist between the District Contract and the Plan, then the information in the Contract shall take precedence.

**Change Orders:** Any supplements or changes to the Contract Agreements or Construction issued plans, Individual Work Scope Agreements, Term Contracts or General Category Work Agreements, Contract Time and these General Conditions shall be in writing and presented in the form of a Change Order.

**Addendum:** Any supplements or changes to individual Task Orders or Contract shall be in writing and presented in the form of an addendum.

**Consummation of Change Orders and Addenda:** Such Change Orders and Addenda executed as described above shall be effective when thereafter signed by the Contractor's Authorized Representative and authorized representative of FOWD.

### **Section 3 – SEVERABILITY**

The Contractor and the District agree that any provision of this contract that is found to be illegal or unenforceable, such term or provision shall be deemed stricken and the remainder of the contract shall remain in full force and effect. Either party having knowledge of such term or provision shall promptly inform the other of the presumed non-applicability of such provision.

### **Section 4 – TASK ORDERS**

Where Task Orders are specified and following execution by both the Contractor and Authorized District Representative of a Contract or Service Agreement, the Task Order shall become a supplement to a general category Agreement, provided, however, that no Task Order or combination of Task Orders cumulatively nor individually shall exceed the authorized dollar value, without the Contractor first receiving from the District a duly issued Contract Change Order authorizing such additional expenditures. **NOTE: (1)** The FOWD Contracting Agent named on the bottom of the General Contract form or, Contracting Agent's designee, so named in writing (collectively the "Contracting Agent"), are the only parties authorized to issue Contract Change Orders for FOWD **(2)** The Authorized FOWD Representative named on the top of the General Contract form or the Authorized Representative's designee are authorized to release Task Orders or addendum to previously issued Task Orders. The Authorized Representative's signature (or Designee's) shall also be required where indicated at the bottom of each individual Task Order for such Task Order to be effective against FOWD.

### **Section 5 – RESPONSIBILITY FOR WORK**

Until the completion and final acceptance by the District, of all the work under and implied by this Agreement, the work shall be under the Contractor's responsible care and charge. The Contractor shall rebuild, repair, restore and make good all injuries, damages, re-erectments, and repairs occasioned or rendered necessary by causes of any nature whatsoever.

### **Section 6 – EXTRA WORK**

The Contractor shall do no extra work except on the written authorization of the District. If the District does authorize extra work, the costs thereof will be added to the monthly invoice upon the completion of the extra work.

### **Section 7 – CONTRACT AMOUNT**

The District agrees to pay, and the Contractor agrees to accept, in full payment for the above work, the sum computed in accordance with the actual amount of each item of work performed or material furnished and incorporated in the work, at the unit price which the Contractor bid for each such item in the Contractor's bid, said unit price to be determined as provided in the proposal.



## **Section 8 – PROGRESS AND FINAL PAYMENTS**

1. On a monthly basis, or as presented in project request for proposal, the Contractor shall present to the District a statement showing the amount of labor and materials incorporated in the work during the preceding month, along with certified payroll documentation. The District personnel shall verify the statement. If accuracy of invoice is satisfactory, a payment will be made in an amount equal to ninety-five percent (95%) of the value to date, based on the contract price, less any previous payments for all work performed and materials actually used by the Contractor during said period. The remaining five percent (5%) retention of the value of the work completed under this contract, if unencumbered, shall be paid after final completion and acceptance of work by the District. Acceptance by the Contractor of said final payment shall constitute a waiver of all claims against the District arising under the Contract Document. The Contractor shall not be paid for any defective, unfinished, disputed, or improper work.
2. Undisputed invoices processing:
  - a) For invoices less than \$25,000, the FOWD will pay the contractor 30 days from the date of invoice.
  - b) For invoices \$25,000 and greater depending on when the invoices are submitted and the timing of the FOWD's Board meeting, the check processing for expenses \$25,000 and greater can take up to 60 days.
3. Pursuant to Part 5, Section 22300 of the Public Contract Code, the Contractor will be permitted to substitute securities for any money withheld by the District to ensure performance under this contract. At the request and expense of the Contractor, securities equivalent to the amount withheld shall be deposited with the District, or with a State or Federally chartered bank in California as the escrow agent, who shall pay such monies to the Contractor upon satisfactory completion of the Contract. At the direction of the District, the securities shall be returned to the Contractor.
4. Alternately, the Contractor may request that the owner shall make payment of retentions earned directly to the escrow agent at the expense of the Contractor. At the expense of the Contractor, Contractor may direct the investment of the payments into the investments upon the same terms provided for in this section for securities deposited by the Contractor. Upon satisfactory completion of the contract, Contractor shall receive from the escrow agent all securities, interest, and payments received by the escrow agent from the owner, pursuant to the terms of this section. The Contractor shall pay to each subcontractor, not later than twenty (20) days following receipt of the payment, the respective amount of interest earned, net of costs attributed to retention withheld from each subcontractor, on the amount of retention withheld to insure the performance of the Contractor.
5. Securities eligible for investment under this section shall include those listed in Section 16430 of the Government Code, or bank or savings and loan certificates of deposit.
6. The Contractor shall be the beneficial owner of any securities substituted for monies withheld and shall receive any interest thereon.
7. Any escrow agreement entered into pursuant to this provision shall be substantially in the form set forth in Section 22300 (e) of the California Public Contract Code.

## **Section 9 – RETENTION OF SUMS CHARGED AGAINST CONTRACTOR**

When, under the provisions of this contract, the District shall charge any sum of money against the

Contractor, the District shall deduct and retain the amount of such charge from the amount of the next succeeding progress estimate, or from any other monies due or that may become due the Contractor from the District. If, on completion or termination of the Contract, sums due the Contractor are insufficient to pay the District's charges against the Contractor, the District shall have the right to recover the balance from the Contractor.

**Right of the District to Withhold Payments:** In accepting work with the District, the Contractor agrees the District may withhold or cancel the whole or any part of any partial payment or final payment to such an extent as may be reasonably necessary to protect the District from loss due to, but not limited to, any one of the following items or a combination of the items:

1. **Defective Work:** Defective work not remedied, regardless of when any such work may be found to be defective.
2. **Claims or Liens:** Claims or liens filed or reasonable evidence indicating probable filing of claims or liens.
3. **Failure of Contractor to Pay for Goods or Services:** Failure of the Contractor to make payments promptly for labor, material, equipment, or other facilities, or to subcontractors.
4. **Ability of Contractor to Complete for Unearned Balance:** A reasonable that work can be completed for the balance unearned.
5. **Damage to Other Work or Property:** Damage to other work or property which is caused either directly or indirectly by the Contractor.
6. **Pending Notice of Completion:** The District may have a "Notice of Completion" published and withhold final payment pending the outcome of the discovery period and subject to all other applicable provisions of these General Conditions.
7. **Settlement of Back Charges:** Settlement of back charges resulting from bonafide claims on totally unrelated work awarded to the Contractor using otherwise unencumbered funds available from current contracted work.
8. **Provision of Listing of Subcontractors and Suppliers:** Payment may be withheld until Contractor has provided a list of all subcontractors, suppliers, or others, who have provided goods and services for work performed, including reasonable time for District to verify Contractor's payment to same.

Whenever the District shall, in accordance herewith, withhold any monies otherwise due to the Contractor, written notice of the amount withheld, and the reasons thereof shall be given the Contractor. Once the Contractor has removed the grounds for such withholding, the District will promptly pay to the Contractor any amounts owed to Contractor from the amount withheld.

#### **Section 10 – NOTICES AND INVOICES**

All notices, invoices and payments shall be made in writing and may be given by personal delivery, via email in pdf format, or by mail. Notices, invoices, and payments sent by United States mail shall be addressed to the designated FOWD and Contractor Authorized Representatives, as applicable, as indicated on the General Contract. When so addressed, all such notices, invoices and payments shall be deemed given upon two days following deposit in the United States mail, all postage prepaid. In all other instances, notices, invoices, and payments shall be deemed given at the time of actual receipt.

### **Section 11 – NO WAIVER BY PAYMENT**

Payment to the Contractor or occupation of the project by the District shall not relieve the Contractor of liability for defective materials or quality of the work used in the completion of the project or for failure to construct the project according to specifications. Acceptance by the Contractor of any payment provided for in this contract shall be a representation by the Contractor to the District that all work performed before the payment became due has been completed by Contractor in accordance with the terms of the contract and according to the specifications.

### **Section 12 – WAGE RATES**

The Contractor acknowledges that the Contractor has examined the California State Prevailing Wage Determination made by the Director of the California Department of Industrial Relations (DIR) and agrees to pay workers not less than the stipulated wage rates. Contractor shall provide the District with current DIR registration number and copies of the prevailing wage payroll with each payment request.

### **Section 13 – EIGHT HOUR DAY LIMITATION**

Contractor agrees that 8 hours labor shall constitute a day's work, and no worker, in the employ of the Contractor, or any subcontractor, doing or contracting to do any part of the Work under this Contract, shall be required or permitted to work more than 8 hours in any one calendar day and 40 hours in any one calendar week; provided that subject to California Labor Code section 1815, a worker may perform work in excess of 8 hours per day or 40 hours per week at not less than one and one-half times the basic rate of pay.

### **Section 14 – INDEMNIFICATION**

To the fullest extent permitted by law, the Contractor shall indemnify and hold harmless and defend the District, its directors, officers, employees, consultants, or authorized volunteers, and each of them from and against:

1. Any and all claims, demands, causes of action, damages, costs, expenses, losses or liabilities, in law or in equity, of every kind and nature whatsoever for, but not limited to, injury to or death of any person including the District and/or the Contractor, or any directors, officers, employees, or authorized volunteers of the District or the Contractor, and damages to or destruction of property of any person, including but not limited to, the District and/or the Contractor or their directors, officers, employees, or authorized volunteers, arising out of or in any manner directly or indirectly connected with the work to be performed under this agreement, however caused, regardless of any negligence of the District or its directors, officers, employees, or authorized volunteers, except the sole negligence or willful misconduct or gross negligence of the District or its directors, officers, employees, or authorized volunteers;
2. Any and all actions, proceedings, damages, costs, expenses, penalties, or liabilities, in law or equity, of every kind or nature whatsoever, arising out of, resulting from, or on account of the violation of any governmental law or regulation, compliance with which is the responsibility of Contractor.
3. Any and all losses, expenses, damages (including damages to the work itself), attorneys' fees, and other costs, including all costs of defense, which any of them may incur with respect to the failure, neglect, or refusal of Contractor to faithfully perform the work and all of the Contractor's obligations under the contract. Such costs, expenses, and damages shall include all costs, including attorneys' fees, incurred by the indemnified parties in any lawsuit to which they are a party.
4. The Contractor shall defend, at Contractor's own cost, expense and risk, any and all such aforesaid suits, actions or other legal proceedings of every kind that may be brought or instituted against the District or District's directors, officers, employees, or authorized volunteers arising out of or in any manner directly or indirectly connected with the work to be performed under this agreement.

5. The Contractor shall pay and satisfy any judgment, award or decree that may be rendered against the District or its directors, officers, employees, or authorized volunteers, in any such suit, action or other legal proceeding.
6. The Contractor shall reimburse the District or its directors, officers, employees, or authorized volunteers, for any and all legal expenses and costs incurred by each of them in connection therewith or in enforcing the indemnity herein provided.
7. The Contractor agrees to carry insurance for this purpose as set out in the specifications. Contractor's obligation to indemnify shall not be restricted to insurance proceeds, if any, received by the District, or its directors, officers, employees, or authorized volunteers.

### **Section 15 – SAFETY**

The Contractor shall execute and maintain the Contractor's work to avoid injury or damage to any person or property. The Contractor shall comply with the requirements of the specifications relating to safety measures applicable in particular operations or kinds of work.

1. In the performance of this contract the contractor shall comply with all applicable federal, state, and local statutory and regulatory requirements including, but not limited to California Department of Industrial Relations (Cal/OSHA) regulations; and the U.S. Department of Transportation Omnibus Transportation Employee Testing Act related to their scope of work and operations. In case of conflict in regulations, the most stringent shall apply. The contractor shall provide all safeguards, safety devices and protective equipment and take any other needed actions necessary to protect the life and health of employees on the job and the safety of the public and to protect property in connection with the performance of the work covered by the contract. Safety precautions shall include but shall not be limited to: adequate life protection and life saving equipment; adequate illumination; instructions in accident prevention for all employees, such as the use of machinery guards, safe walkways, scaffolds, ladders, bridges, gang planks, confined space procedures, trenching and shoring, fall protection, and other safety devices; equipment and wearing apparel as are necessary or lawfully required to prevent accidents, injuries, or illnesses; and adequate facilities for the proper inspection and maintenance of all safety measures.
2. Contractor must obtain all applicable Division of Occupational Safety and Health (CAL-OSHA) permit(s) and others required by California Labor Code and California Government Code, prior to the initiation of any practices, work, method, operation, or process related to the work covered in the contract. Permits required by governmental authorities will be obtained at Contractor's expense.
3. It is a condition of this contract, and shall be made a condition of each sub-contract which the contractor enters into pursuant to this contract, that the contractor and any subcontractor shall not permit any employee, in performance of the contract, to work in surroundings or under conditions which are unsanitary, hazardous or dangerous to their health or safety, as determined under Cal/OSHA safety and health standards.
4. The Contractor shall be responsible for the safeguarding of all utilities. At least two working days before beginning work, the Contractor shall contact for a Underground Service Alert (USA) in order to determine the location of sub-structures. The Contractor shall immediately notify Fair Oaks Water District and the utility owner if they disturb, disconnect, or damage any utility.
5. In accordance with Section 6705 of the California Labor Code, the Contractor shall submit to Fair Oaks Water District specific plans to show details of provisions for worker protection from caving ground during excavations of trenches of five feet or more in depth. The excavation/trench safety

plan shall be submitted to and accepted by Fair Oaks Water District prior to starting excavation. The trench safety plan shall have details showing the design of shoring, bracing, sloping or other provisions to be made for worker protection from the hazard of caving ground. If such a plan varies from the shoring system standards established by the Construction Safety Orders of the California Department of Industrial Relations (Cal/OSHA), the plan shall be prepared by a California registered civil or structural engineer. As part of the plan, a note shall be included stating that the registered civil or structural engineer certifies that the plan complies with the Cal/OSHA Construction Safety Orders, or that the registered civil or structural engineer certifies that the plan is not less effective than the shoring, bracing, sloping or other provisions of the Safety Orders. In no event shall the Contractor use a shoring, sloping, or protective system less effective than that required by said Construction Safety Orders. Submission of this plan in no way relieves the Contractor of the requirement to maintain safety in all areas. If excavations or trench work requiring a Cal/OSHA permit are to be undertaken, the Contractor shall submit their permit with the excavation/trench work safety plan to Fair Oaks Water District before work begins.

6. In the event of damage to any property or bodily injury to any person, the Contractor's Representative will provide immediate verbal notification (to be followed by a detailed written report thereon within forty-eight (48) hours) to the FOWD Inspector, or alternatively, to the Authorized FOWD Representative named in the Contract Agreement, or alternatively, Task Order.

## **Section 16 – INSURANCE**

**Limits** - The Contractor shall maintain limits no less than the following:

1. **General Liability - Commercial General Liability (CGL)** - Insurance Services Office (ISO) Commercial General Liability Coverage (Occurrence Form CG 00 01) including products and completed operations, property damage, bodily injury, personal and advertising injury with limit of at least two million dollars (\$2,000,000) per occurrence or the full per occurrence limits of the policies available, whichever is greater. If a general aggregate limit applies, either the general aggregate limit shall apply separately to this project/location (coverage as broad as the ISO CG 25 03, or ISO CG 25 04 endorsement provided to FOWD or the general aggregate limit shall be twice the required occurrence limit.
2. **Automobile Liability** - Insurance Services Office (ISO) Business Auto Coverage (Form CA 00 01), covering Symbol 1 (any auto) with limit of one million dollars (\$1,000,000) for bodily injury and property damage each accident.
3. **Workers' Compensation Insurance** - The Contractor shall provide workers' compensation coverage as required by the State of California, with Statutory Limits, and Employer's Liability Insurance with limit of no less than \$1,000,000 per accident for bodily injury or disease. **Waiver of Subrogation** (also known as Transfer of Rights of Recovery Against Others to Us): The Contractor hereby agrees to waive rights of subrogation to obtain endorsement necessary to affect this waiver of subrogation in favor of the FOWD, its directors, officers, employees, and authorized volunteers, for losses paid under the terms of this coverage which arise from work performed by the Named Insured for the FOWD; this provision applies regardless of whether or not the FOWD has received a waiver of subrogation from the insurer.
4. **Builder's Risk** – (Course of Construction) if necessary- insurance utilizing an “All Risk” (Special Perils) coverage form with limits equal to the completed value of the project and no coinsurance penalty provision.

**Responsibility for Work** - Until the completion and final acceptance by FOWD of all the work under and implied by this agreement, the work shall be under the Contractor's responsible care and charge. The Contractor shall rebuild, repair, restore and make good all injuries, damages, re-erectments, and repairs occasioned or rendered necessary by causes of any nature whatsoever.

The Contractor shall provide and maintain builder's risk (course of construction) covering all risks of direct physical loss, damage or destruction to the work in the amount specified in the General Conditions, to insure against such losses until final acceptance of the work by FOWD. Such insurance shall insure at least against the perils of fire and extended coverage, theft, vandalism and malicious mischief, and collapse. The Policy shall be endorsed with FOWD, its directors, officers, employees, and authorized volunteers named as loss payee, as their interest may appear. The making of progress payments to the Contractor shall not be construed as creating an insurable interest by or for Member Water Agency or be construed as relieving the Contractor or their subcontractors of responsibility for loss from any direct physical loss, damage or destruction occurring prior to final acceptance of the work by FOWD.

### **Required Insurance Provisions**

The general liability and automobile liability policies are to contain, or be endorsed to contain the following provisions:

1. The District, its directors, officers, employees, or authorized volunteers are to be given insured status (via ISO endorsement at least as broad as CG 20 10 11 85 or **both** CG 20 10 10 01 and CG 20 37 10 01 (or earlier edition date), or insurer's equivalent for general liability coverage) specifically naming all of the District parties required in this agreement, or using language that states "as required by contract") and all Subcontractors hired by Contractor must also have the same forms or coverage at least as broad (via CG 20 38 04 13) with respects to liability arising out of activities performed by or on behalf of the Contractors including products and completed operations of the Contractor; premises owned, occupied or used by the Contractor; or automobiles owned, leased, hired or borrowed by the Contractor. The coverage shall contain no special limitations on the scope of protection afforded to the District, its directors, officers, employees, or authorized volunteers.
2. For any claims related to this project, Contractor's insurance shall be primary insurance (with at least as broad as ISO CG 20 01 04 13) as respects to the District, its directors, officers, employees, or authorized volunteers. Any insurance, self-insurance, or other coverage maintained by the District, its directors, officers, employees, or authorized volunteers shall not contribute to it.
3. Any failure to comply with reporting or other provisions of the policies including breaches of warranties shall not affect coverage provided to the District, its directors, officers, employees, or authorized volunteers.
4. Contractor's insurance shall apply separately to each insured against whom claim is made or suit is brought, except with respect to the limits of the insurer's liability.
5. Each insurance policy required by this clause shall state or be endorsed to state that coverage shall not be canceled by either party, except after thirty (30) days (10 days for non-payment of premium) prior written notice by U.S. mail has been given to the District.
6. Such liability insurance shall indemnify the Contractor and the subcontractors against loss from liability imposed by law upon, or assumed under contract by, the Contractor or the subcontractors for damages on account of such bodily injury (including death), property damage, personal injury and completed operations and products liability.

7. The general liability policy shall cover bodily injury and property damage liability, owned and non-owned equipment, blanket contractual liability, completed operations liability, explosion, collapse, underground excavation and removal of lateral support.
8. The automobile liability policy shall cover all owned, non-owned, and hired automobiles.
9. Any deductible or self-insured retention must be declared to and approved by the District. At the option of the District, the insurer shall either reduce or eliminate such deductibles or self-insured retentions.
10. All the insurance shall be provided on policy forms and through companies satisfactory to the District. The insuring companies shall have a current A.M. Best rating of no less than A-: VII or equivalent or as otherwise approved by the District.
11. The Contractor and all subcontractors shall insure (or be a qualified self-insured) under the applicable laws relating to workers' compensation insurance, all of their employees working on or about the construction site, in accordance with the "Workers' Compensation and Insurance Act," Division IV of the Labor Code of the State of California and any Acts amendatory thereof. The Contractor shall provide employer's liability insurance in the amount of at least \$1,000,000 per accident for bodily injury and disease.
12. The Contractor shall provide and maintain builder's risk insurance (or installation floater) covering all risks of direct physical loss, damage or destruction to the work in the amount specified in the General Conditions, to insure against such losses until final acceptance of the work by the District. Such insurance shall include explosion, collapse, underground excavation and removal of lateral support. The District shall be a named insured on any such policy. The making of progress payments to the Contractor shall not be construed as creating an insurable interest by or for the District or be construed as relieving the Contractor or their subcontractors of responsibility for loss from any direct physical loss, damage or destruction occurring prior to final acceptance of the work by the District.
13. The insurer shall waive all rights of subrogation against the District, its directors, officers, employees, or authorized volunteers.

#### **Verification of Coverage - Evidence of Insurance**

Prior to execution of the agreement, the Contractor shall file with Fair Oaks Water District a certificate of insurance (Acord Form 25 or equivalent) signed by the insurer's representative, evidencing the coverage required by this agreement. Such evidence shall include an additional insured endorsement signed by the insurer's representative and evidence of waiver of rights of subrogation against Fair Oaks Water District (if builder's risk insurance is applicable). Such evidence shall also include (1) attached additional insured endorsements with primary & non-contributory wording, (2) Workers' Compensation waiver of subrogation, and (3) a copy of the CGL declarations or endorsement page listing all policy endorsements, and confirmation that coverage includes or has been modified to include Required Provisions 1-13 above. The District reserves the right to obtain complete, certified copies of all required insurance policies, at any time. Failure to continually satisfy the Insurance requirements is a material breach of contract.

#### **Continuation of Coverage**

The Contractor shall, upon demand of Fair Oaks Water District, deliver evidence of coverage showing continuation of coverage for at least (5) years after completion of the project. Contractor further waives all rights of subrogation under this agreement when any of the required coverages expire during the term of this agreement, the Contractor shall deliver the renewal certificate(s) including the general liability

additional insured endorsement and evidence of waiver of rights of subrogation against Fair Oaks Water District (if builder's risk insurance is applicable) to Fair Oaks Water District at least ten (10) days prior to the expiration date.

### **Section 17 – BONDS**

**Performance Bond:** The Contractor shall obtain at its sole cost and expense and provide to District a performance bond in the amount equal to 100% of this Contract for the faithful performance of the work to be done under the terms of this contract, with sureties as may be agreeable to the District.

**Payment Bond:** The Contractor shall obtain at its sole cost and expense and provide to District a payment bond in the amount equal to 100% of this Contract for the faithful performance of the work to be done under the terms of this contract, as provided for in Section 3247 of the California Civil Code with sureties as may be agreeable to the District.

**Maintenance Bond:** Prior to the District Preliminary Acceptance Letter issuance for the new water facilities constructed by the Contractor per project documents, the Contractor shall furnish an overall maintenance bond or corporate surety bond, payable to the District. This bond, which shall be executed by a duly licensed surety company authorized to do business in the State of California, shall protect the District against the results of any failure attributable to any cause, including, but not limited to, faulty material, poor workmanship, and defective equipment or damage of the work occurring within the Guarantee period under the provisions of the Guarantee.

The bond shall guarantee the Contractor's responsibility as outlined above for a period of one (1) year or shall remain in effect for as long as the Guarantee remains in effect. The bond shall be provided on forms to be approved by the District and shall be in the sum of not less than one-hundred percent (100%) of awarded amount including any change orders issued during the project construction.

The bonds must comply with California Civil Code sections 3247 and 3248 and applicable provisions of the California Bond and Undertaking Law (Cal. Code of Civil Procedure § 995.010 et seq.).

### **Section 18 – SUBCONTRACTORS**

None of this work may be delegated or sub-contracted without written consent of the District prior to work started. The successful bidder shall not assign its work or any of its rights hereunder to another contractor. The District may require written documentation of qualifications and references for any subcontractor being considered for District approval to perform any part of any work under this Contract.

In the event that the Contractor employs other contractors (subcontractors) as part of the work covered by this agreement, it shall be the Contractor's responsibility to require and confirm that each subcontractor meets the minimum insurance requirements specified above.

The General Contract shall bind Contractor's subcontractors, successors, and assigns, and that Contractor shall cause its employee, agents, and subcontractors to comply with all requirements of the General Contract and these General Conditions.

If, at any time during the performance of this Contract, Contractor fails to maintain any item of the required insurance in full force and effect, Contractor shall immediately discontinue all work under the Contract and District will withhold all Contract payments due or that become due until notice is received by District that such insurance has been restored in full force and effect and that the premiums therefore have been paid for a period satisfactory to the District.



### **Section 19 – GUARANTEE**

Excepting only items of routine maintenance, ordinary wear and tear and unusual abuse or neglect, Contractor guarantees all work executed by the Contractor and all supplies, materials and devices of whatsoever nature incorporated in, or attached to the work, or otherwise delivered to the District as a part of the work pursuant to the Contract, to be absolutely free of all defects in the quality of work and materials for a period of **one (1) year** after final acceptance by the District of work performed. The Contractor shall repair or replace any or all such work or material, together with all or any other work or material which may be displaced or damaged in so doing, that may prove defective in the quality of work or material within said one year guarantee period without expense or charge of any nature whatsoever to the District.

In the event that the Contractor shall fail to comply with the conditions of the foregoing guarantee within ten (10) days after being notified of the defect in writing, the District shall have the right, but shall not be obligated to repair or obtain the repair of the defect, and the Contractor shall pay to the District on demand all costs and expense of such repair. Notwithstanding anything herein to the contrary, in the event that any defect in the quality of work or material covered by the foregoing guarantee results in a condition which constitutes an immediate hazard to the health or safety, or any property interest, or any person, District shall have the right to immediately repair, or cause to be repaired, such defect, and the Contractor shall pay to District on demand all costs and expense of such repair, or District may elect to subtract cost from withheld retention. The foregoing statement relating to hazards to health, safety or property shall be deemed to include either temporary or permanent repairs, which may be required as determined in the sole discretion and judgment of District.

### **Section 20 – LAWS, REGULATIONS AND PERMITS**

The Contractor shall give all notices required by law and comply with all laws, ordinances, rules, and regulations pertaining to the conduct of the work. The Contractor shall be liable for all violations of the law in connection with work furnished by the Contractor. If the Contractor observes that the drawings or specifications are at variance with any law or ordinance, rule or regulation, the Contractor shall promptly notify the District in writing and any necessary changes shall be made by written instruction or change order. If the Contractor performs any work knowing it to be contrary to such laws, ordinances, rules or regulations and without giving notice to the District appointed engineer, the Contractor shall bear all costs arising there from.

All necessary permits or similar authorizations required for this construction as per the "Construction Issued" Plans for such work will be obtained by the District unless otherwise stated. Copies of all permits will be furnished to the Contractor. Bonds that may be required to obtain the permits shall be furnished by the Contractor. Contractor shall maintain a copy of such permits with the Crew installing the work.

### **Section 21 – AUTHORIZED PERSONNEL**

Contractor shall not accept direction or orders from any person other than the General Manager, Technical Services Manager, or the person(s) whose name(s) is listed as "other authorized representative(s)."

### **Section 22 – UNLAWFUL HARASSMENT**

The District is committed to providing a work environment free of unlawful harassment. The Contractor and subcontractors shall adhere to the District's policy prohibiting sexual harassment, and harassment based on pregnancy, childbirth, or related medical conditions, race, religious creed, color, national origin or ancestry, physical or mental disability, medical condition, marital status, age, sexual orientation or any other basis protected by federal, state or local law or ordinance or regulations. All such harassment is unlawful. District's anti-harassment policy applies to all persons, including but not limited to, contractors and subcontractors involved in the operation of the District and prohibits unlawful harassment by any employee of the District, including supervisors, coworkers, contractors and subcontractors.

### **Section 23 – SCOPE OF WORK**

The Contractor shall furnish all labor, materials, equipment, tools, facilities, and transportation necessary to perform the work submitted in the bid proposal. Work must be performed and completed in accordance with District Standard and/or Project Specifications to the satisfaction of the District, and in the manner designated in, and in strict conformity with the Contract Documents.

Any change in the scope of the professional services to be done, method of performance, nature of materials or price thereof, or to any other matter materially affecting the performance or nature of the professional services will not be paid for or accepted unless such change, addition or deletion be approved in advance, in writing by a supplemental agreement by the Fair Oaks Water District. Contractor's "authorized representative(s)" has (have) the authority to execute such written change for Contractor.

### **Section 24 – DISTRICT'S RIGHT TO TERMINATE / RIGHT TO PROCEED**

If the Contractor refuses or fails to prosecute the work, or any separable part thereof, with such diligence as will insure its completion within the time specified in Contract, or any extension thereof, or fails to complete said work within such time, the District General Manager may, by written notice to the Contractor, terminate their right to proceed with the work or such part of the work as to which there has been delay. In such event, the District may take over the work and prosecute the same to completion, by contract or otherwise, and the Contractor shall be liable to the District for any excess cost occasioned the District thereby, until such reasonable time as may be required for the final completion of the work.

### **Section 25 – ASSIGNMENT BY CONTRACTOR**

This contract is for the personal services of the Contractor in construction of the Project and the Contractor may not assign this contract, or delegate Contractor's duties under this contract to any other person or entity without the prior written consent of District.

1. **Proof of Financial Responsibility:** All suppliers and/or carriers hired or used by Contractor or FOWD (including, without limitation, suppliers and/or carriers of hazardous materials) shall provide FOWD with proof of financial responsibility in accordance with all applicable law, including, without limitation, the Federal Motor Carrier Act of 1980 (driver's insurance), as amended, the rules and regulations of the Federal Interstate Commerce Commission and applicable state law.
2. **Shut Downs and Shut Down Fees:** For all shut downs, a forty-eight (48) hour minimum advance notice must be given by the Contractor to the District at the address indicated on the bid sheet. All shut downs must be made by District personnel. The District will charge the Contractor a shut-down fee when the Contractor works overtime or on weekends for its own convenience. The District shut-down fee will be \$100 per day or actual time and material cost incurred by the District, whichever is greater. The Contractor must have prior approval for such shut downs from the District's designee so named in writing.
3. **Traffic Control and Safety Regulations:** Contractor assumes the responsibility to observe all applicable federal, state and local laws, regulations and guidelines in the performance of its work, including without limitation the regulations established by O.S.H.A. and the Work Area Traffic Control Handbook, current edition (Los Angeles: Building News, Inc.) and to perform all work in a safe and prudent manner. Without in any way limiting that responsibility or assuming responsibility for safety, FOWD is particularly concerned that the following rules are strictly observed:

A supervisor shall be present at all times to ensure that all personnel at the job site perform in accordance with all applicable safety requirements; and

All personnel at the job site shall be properly equipped and attired, including an approved hard hat, protective eye wear, orange safety vest and appropriate breathing apparatus as may be required for protection from paint fumes; and

Safety/Warning Signs shall be placed around the perimeter of the work area. Work performed in streets shall have safety devices in place in accordance with the Work Area Traffic Control Handbook and other applicable governmental rules and regulations.

4. **Damage to Property:** The Contractor shall assume the risk of all loss of or damage to property or materials during the progress of said work. The Contractor shall not disturb the facilities of other utilities or other underground structures, and it shall be liable for damages caused by its operations. Where such information is available, some effort has been made to designate the approximate location and kind of known substructures as shown on the plans, but this shall not relieve the Contractor of its responsibility to protect any and all utility lines, shown or not shown on the plan, during the performance of its work under this Contract. The Contractor shall provide a minimum of forty-eight (48) hours' notice of intent to start work to those agencies having substructures in or jurisdiction over the construction area including but not necessarily limited to Underground Service Alert.
5. **Coordination of Work:** The Contractor shall be responsible to plan and coordinate its work with other contractors working in the same project area. Loss or damage resulting from a failure to so plan or coordinate shall be the Contractor's sole responsibility.
6. **Pre-Inspection of Site:** It shall be the Contractor's responsibility to ascertain the existence of any conditions affecting the work which would have been disclosed by reasonable examination of the site. The Contractor shall, upon discovering any conditions not indicated on the plans, immediately bring them to the attention of the District's assigned representative.
7. **Location of Connections:** The Contractor shall, unless instructed to the contrary by the District, excavate and expose existing District facilities at all locations where a connection (tie-in) is to be made, as shown on the plans, and shall verify that such conditions are as indicated on the plan **prior** to requesting a shutdown of existing mains.

The Contractor shall field locate points of connection or tie-in when not designated on the plan. Forty-eight (48) hours advance notification is required. Conditions differing from those indicate on the plan and requiring additional material, or material with different dimensions, shall be brought to the attention of the District's assigned representative immediately.

Any additional expenses incurred by the Contractor as a result of failure to verify existing conditions or utilities shall be considered its sole expense and will not be reimbursed by the District.

8. **Performance of Work:** Where conflicts or omissions arise involving performance of work by the Contractor under the District's Specifications, then the following priority shall be observed:
  - a. Fair Oaks Water District Construction documents.
  - b. Standards of the American Water Works Association.
  - c. Sacramento County Specifications
  - d. Standard Specifications for Public Works Construction.
  - e. Requirements of federal, state, county, and local law.

## **Section 26 – NOTICE TO START WORK**

1. **Pre-Construction Meeting:** When the cost of the jobs exceeds \$10,000, or otherwise when directed in writing by the District, the Contractor shall arrange for a pre-construction meeting to be held at the job site or other suitable location. It shall be the Contractor's responsibility to notify all utilities and agencies maintaining facilities or having jurisdiction within the area of work as well as the District's Inspector when assigned, or alternative, the assigned Authorized FOWD Representative.
2. **Scheduling of Work:** Prior to the start of any work, the Contractor shall upon request submit its proposed construction schedule in the form of a tabulation, chart, graph or as otherwise reasonably requested in sufficient detail to show the chronological relationship of all activities of the project, including the estimated number of working days for each phase when more than one phase is involved.
3. **Scheduled Start Date:** The Contractor, in accepting individual contracts, agrees to start the work within ten (10) working days after receipt of contract and written request from the Authorized FOWD Representative to start the work, or alternatively, on the date as indicated by the District as a condition of award in its original bid request and further included in its General Contract. Failure of Contractor to start the work in accordance with the provisions of this Article shall be grounds for termination.
4. **Change to Previously Scheduled Start Dates:** The District reserves the right to determine the sequence by which jobs are to be performed when the Contractor has been awarded more than one job with the District. In the event of scheduling conflicts where more than one District entity is involved, the District's Director of Operations Support shall determine the priority. The District further reserves the right to adjust the order of priority for its convenience at no additional cost to the District where the Contractor has not yet commenced mobilization of a previously scheduled job.
5. **Supervision of Work:** The Contractor shall provide the Authorized FOWD Representative, named on page 2 (two) of the District's Construction Agreement, with the name and contact information of the supervisor responsible for the work. Such notification shall be provided a minimum of two (2) working days in advance of the scheduled start date. The Contractor shall assure that all work performed for the District is at all times supervised and staffed by qualified personnel thoroughly equipped and trained in the skills required to fulfill the work, and that such employees and agents will, at all times, comply with all applicable laws, ordinances and regulations (including, without limitation, all safety regulations, applicable to persons at a project site) that may in any manner apply to the performance of its work. The Contractor assumes all liability for loss, damage or injury to the person or property of itself and its owners, officers, agents, and employees.
6. **Protection of Work and Clean up:** Until the final completion of the work and acceptance thereof by the District, the Contractor shall care for and maintain all areas affected by its construction. The Contractor shall properly remove all debris, rubbish, and spoils from the site of the work after its completion and prior to acceptance thereof by the District.

The Contractor shall immediately remove any item posing a safety hazard and at the end of each working day remove or otherwise move from view all items presenting an untidy appearance.

All landscaping must be restored to its original condition and to the satisfaction of the District. Potentially sensitive situations should be videotaped by Contractor prior to commencement of the work.

Dust control shall be maintained as specified in Section 7-8 of the "*Standard Specifications for Public Works Construction*", current edition.

7. **Inspection Fees:** The District will charge the Contractor an inspection fee only when the Contractor, for its own convenience, elects to work outside of the defined workday.

Inspection request for weekends and holidays must be received in writing by Authorized FOWD Representative named in the Contract Agreement, or alternatively Task Order.

8. The foregoing in no way limits the obligation of the Contractor to assume full responsibility for the observance of all applicable safety and occupational health rules and regulations.

## **Section 27 – TERMINATION OF CONTRACT AGREEMENTS**

**Termination Resulting from Delays by Contractor:** If the District determines that the Contractor is not diligently pursuing the work, the District will so notify the Contractor in writing, specifying what steps need to be taken to correct the situation. The additional cost to the Contractor in rectifying the situation, if any, shall be its sole cost and responsibility. Failure by the Contractor to take the necessary steps to commence the work within fifteen (15) calendar days of notice to proceed or to diligently complete the work may result in cancellation of the remaining work. Any additional cost to the District due to such cancellation of work shall be the Contractor's responsibility, and no further payment if any will be made by the District until all cost are determined. Contractor will be given written notice of termination.

**Termination Resulting From Default by Contractor:** When, in the opinion of the District, the Contractor is not performing its obligations in accordance with the Contract, or has become insolvent, or has sub-contracted work without the written approval of the District, the Contract may be canceled. In the event of cancellation, the Contractor shall be paid for the actual amount of work completed less any damages or expense incurred by the District as a result of such cancellation. If the District's damages or expenses so incurred exceed amounts due to Contractor, Contractor shall pay the District the difference upon demand. Payment for actual work completed will be based on bid prices or fractions thereof and field evaluation of work completed. The District will not be held liable for damages to the Contractor resulting from cancellation for the reasons set forth above. The Contractor shall be notified in writing specifying the reasons for cancellation, and notice shall be served upon the Surety when appropriate. Contractor will be given written notice of termination.

## **Section 28 – ENTIRE AGREEMENT**

**Entire Understanding:** These General Conditions and the provisions and specifications contained in the General Contract form; FOWD Pipeline Requisition; Individual Work Scope Agreements; Term Contracts, and General Category Work Agreements, including awarded Task Orders thereto, and including attachments incorporated in such agreements by reference; represent the entire understanding for such Contract Agreements between the District and Contractor and any negotiations, proposals or oral agreements are intended to be integrated in such agreements and to be superseded by such Contract Agreements. By executing the General Contract form, Contractor waives all provisions of any printed form of agreement supplied or prepared by it that might otherwise be incorporated into a Contract Agreement, to the extent any such document is inconsistent with these General Conditions, excepting as noted below.

## **Section 29 – ATTORNEYS' FEES**

Should any litigation be commenced between the parties to this agreement concerning the project, any provisions of this contract, or the rights and obligations of either in relation thereto, the party prevailing in the litigation shall be entitled to a reasonable sum as and for the party's attorneys' fees in the litigation.

## **Section 30 – ARBITRATION**

**Basis for Settling Disputes and Disagreements:** Any dispute or disagreement arising between Contractor and District in connection with a breach or alleged breach of the Contract Agreements, including Task Orders and/or these General Conditions governing such Contract Agreements, that is not resolved to the mutual

satisfaction of the parties within thirty (30) days (or such longer period as may be mutually agreed upon) from the date that either party informs the other in writing that such dispute or disagreement exists, shall be solely and finally settled by a single arbitrator in accordance with the Commercial Arbitration Rules (the "Arbitration Rules") of the American Arbitration Association (the "AAA"), in effect on the date that such notice is given, with the following exception: The party that demands arbitration of the unresolved dispute or disagreement shall in writing specify the matter to be submitted to arbitration and at the same time choose and nominate a competent person to act as the arbitrator. Within fourteen (14) days after receipt of such written notice, the other party shall indicate in writing its concurrence or non-concurrence in the arbitrator nominated by the other party. If the parties concur in the proposed arbitrator, that arbitrator shall promptly resolve the question in dispute or disagreement in accordance with the Arbitration Rules. If the parties fail to concur in the proposed arbitrator, then upon application by either party, the dispute or disagreement shall be referred for resolution by a single arbitrator appointed in accordance with the Arbitration Rules by the AAA.

1. **Performance of Work During Arbitration:** Notwithstanding this Section 25, during the pendency of any arbitration proceedings, unless otherwise requested by FOWD, Contractor shall proceed diligently with performance of the Contract Agreements and Contractor and FOWD shall continue to be bound thereby.
2. **Location for Arbitration Proceedings:** Any arbitration proceedings hereunder shall be conducted in Sacramento County, California.
3. **Arbitration Award:** The arbitration award shall be made final and binding upon the Contractor and District and judgment may be entered thereon, upon the application of either party, by any court having jurisdiction.
4. **Cost of Arbitration:** Each party shall bear the cost of preparing and presenting its case; but the cost of arbitration, including the fees and expenses of the arbitrator(s), will be paid solely by the losing party.
5. **Survival of Arbitration Rights Beyond Termination of Contract Agreements:** This Section 25 shall survive termination of any Contract Agreement, including any applicable Task Order and these General Conditions governing such agreements with respect to all claims pending at the time of termination.

By signing below, the parties have read and agreed to the General Terms & Conditions (Exhibit A).

**DISTRICT:**

**CONTRACTOR:**

\_\_\_\_\_  
(Signature)

\_\_\_\_\_  
(Signature)

Print: \_\_\_\_\_

Print: \_\_\_\_\_

Title: General Manager\_\_\_\_\_

Title: \_\_\_\_\_

**EXHIBIT B**

**WATER MAINT REPLACEMENT PLAN ON NEW YORK AVENUE  
(PHASE I)**

# FAIR OAKS WATER DISTRICT

## FAIR OAKS, CALIFORNIA

# WATER MAIN REPLACEMENT PLAN ON NEW YORK AVE. (PHASE I)

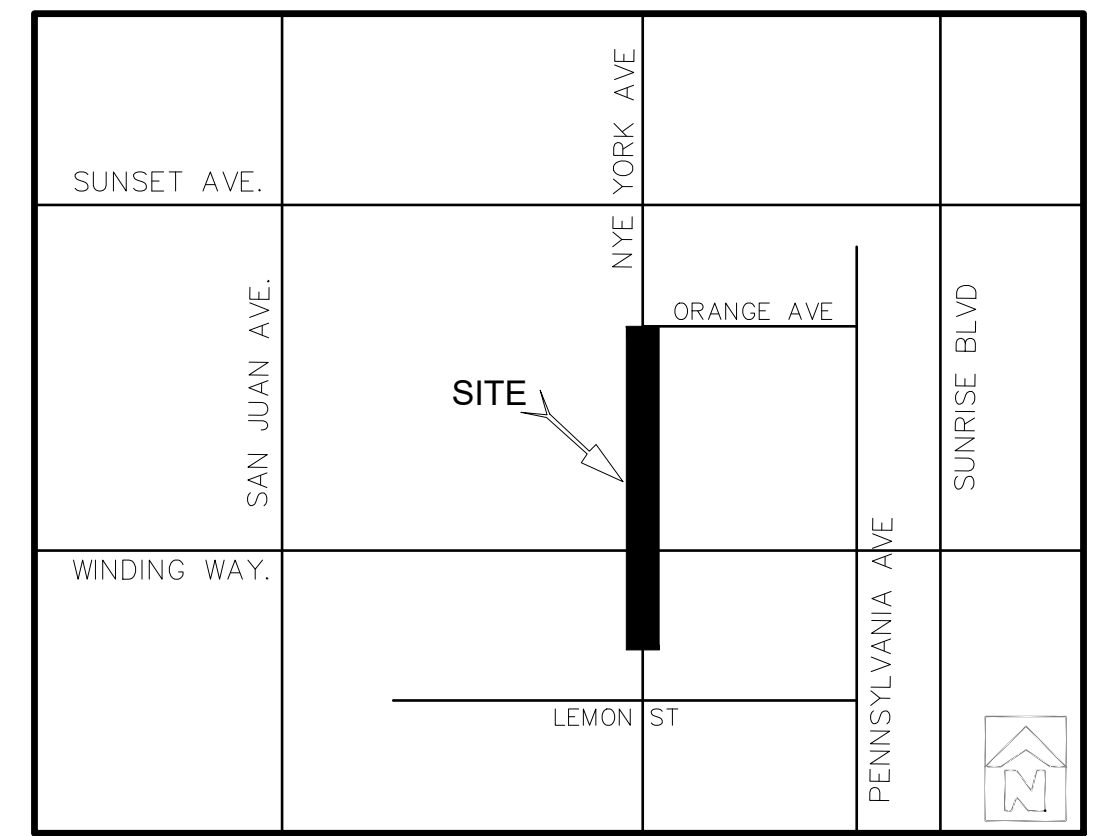

VICINITY MAP

NOT TO SCALE

**LIST OF ABBREVIATIONS:**

AC	ASPHALTIC CONCRETE
AB	AGGREGATE SUBBASE
AVE	AVENUE
AVRV	AIR AND VACUUM RELEASE VALVE
BLVD	BOULEVARD
BNDY	BOUNDARY
BOC	BACK OF CURB
BO	BLOW OFF VALVE
BOW	BACK OF WALK
BV	BUTTERFLY VALVE
C	CABLE/TELEPHONE CLASS
CL	CLEAR
CLR	COMBINATION
COMB.	COMBINATION
C/L	CENTERLINE
CONC.	CONCRETE
CONST.	CONSTRUCT
CT	COURT
C&G	CURB AND GUTTER
DEL	DETAIL
DIA.	DIAMETER
DIP	DUCTILE IRON PIPE
DR	DRIVE
D/W	DRIVEWAY
EX.	EXISTING
ELEV.	ELEVATION
EP	EDGE OF PAVEMENT
ESMT	EASEMENT
FE	FLANGED END
FG	FINISH GRADE
FH	FIRE HYDRANT
F/L	FLOW LINE
FOWD	FAIR OAKS WATER DISTRICT
GALV.	GALVANIZED
GRATE	GRATE
G	GAS MAIN
GV	GATE VALVE
HGL	HYDRAULIC GRADE LINE
HP	HIGH POINT
INV.	INVERT
IRR	IRRIGATION
INTX	INTERSECTION
JP	JOINT POLE
L	LENGTH
LF	LINEAR FEET
LN	LANE
LP	LOW POINT
LT	LEFT
MAX.	MAXIMUM
MH	MANHOLE
MIN.	MINIMUM
MJ	MECHANICAL JOINT
NE	NORTHEAST
N.Y.A.	NEW YORK AVE
O.C.	ON CENTER
O.D.	OUTSIDE DIAMETER
P/L	PROPERTY LINE
(P)	PROPOSED
PSI	POUND PER SQUARE INCH
PT	POINT
PVC	POLYVINYL CHLORIDE PIPE
RL	RESTRAINED LENGTH
RT	RIGHT
ROW	RIGHT OF WAY
S	SLOPE
SD	STORM DRAIN
SE	SOUTHEAST
SS/(S)	SANITARY SEWER
STA.	STATION
TBC	TOP BACK OF CURB
TWM	TOP OF WATER MAIN
TP	TOP OF PAVEMENT
TP.	TYPICAL
W	WATER
W/	WITH
W.M.	WATER MAIN
W.S.	WATER SERVICE

**LIST OF DRAWINGS**

TITLE SHEET, PIPE QUANTITY, TYPE, GENERAL NOTES, AND LIST OF DRAWINGS	SHEET 1 OF 7
NEW YORK AVE, PLAN--PROFILE STA. 15+00 TO STA. 20+00	SHEET 2 OF 7
NEW YORK AVE, PLAN--PROFILE STA. 20+00 TO STA. 25+00	SHEET 3 OF 7
NEW YORK AVE, PLAN--PROFILE STA. 25+00 TO STA. 30+00	SHEET 4 OF 7
NEW YORK AVE, PLAN--PROFILE STA. 30+00 TO STA. 33+00	SHEET 5 OF 7
POC, EROSION, AND SEDIMENT CONTROL DETAILS	SHEET 6 OF 7
FOWD STANDARD DRAWINGS	SHEET 7 OF 7

**LEGEND:**

	PROPOSED (P) WATER SERVICE
	EXISTING (EX.) WATER SERVICE
	(P) WATER GATE VALVE
	EX. WATER GATE VALVE
	(P) AIR RELEASE VALVE
	EX. AIR RELEASE VALVE
	(P). BACKFLOW DEVICE
	EX. BACKFLOW DEVICE
	EX. FIRE HYDRANT ASSEMBLY
	(P) BLOW OFF VALVE
	EX. BLOW OFF VALVE
	(P). WATER LINE
	EX. WATER LINE
	EX. CABLE/TELEPHONE
	EX. ELECTRICAL OVERHEAD
	EX. ELECTRICAL UNDERGROUND
	EX. SANITARY SEWER MAIN
	EX. STORM DRAIN

ENCROACHMENT PERMIT #ENUC2024-00246

**POTHOLE INSTRUCTION NOTE:**

PRIOR TO BEGINNING CONSTRUCTION OF PROPOSED WATER FACILITIES, THE CONTRACTOR SHALL POTHOLE THE EXISTING UTILITIES SHOWN ON THESE PLANS AND THE UTILITIES MARKED BY USA. CONTRACTOR SHALL COORDINATE TIMING OF THE POTHOLE WORK WITH FAIR OAKS WATER DISTRICT(FOWD). FOWD SHALL BE NOTIFIED TWO (2) WORKING DAYS PRIOR TO POTHOLING.

**TRAFFIC CONTROL PLAN NOTE:**

A TRAFFIC CONTROL PLAN SHALL BE PREPARED BY THE CONTRACTOR AND SUBMITTED TO SACRAMENTO COUNTY CONSTRUCTION MANAGEMENT AND INSPECTION DIVISION FOR REVIEW AND APPROVAL PRIOR TO COMMENCEMENT OF ANY WORK. AN ENCROACHMENT PERMIT OR PLAN APPROVAL MUST FIRST BE OBTAINED PRIOR TO ANY WORK COMMENCING WITHIN THE COUNTY RIGHT-OF-WAY.

USA NORTH



Know what's below.  
Call before you dig.

811/800 227-2600

**FAIR OAKS WATER DISTRICT- GENERAL NOTES**  
REVISED: APRIL 2023

- THESE NOTES APPLY** TO THE CONSTRUCTION OF PUBLIC WATER FACILITIES WITHIN THE FAIR OAKS WATER DISTRICT (FOWD) SERVICE AREA. ALL WORK SHALL BE PERFORMED IN ACCORDANCE WITH THE FOWD APPROVED IMPROVEMENT PLANS AND THE MOST RECENT VERSION OF THE FOWD'S STANDARD SPECIFICATIONS MANUAL.
- IMPROVEMENT PLANS APPROVAL** - FOWD'S APPROVAL IS VALID FOR A PERIOD OF ONE (1) YEAR FROM THE DATE OF SIGNATURE. PLANS SHALL BE SUBJECT TO REVIEW AND RE-APPROVAL THEREAFTER. THE CONTRACTOR SHALL NOTIFY FOWD IMMEDIATELY IN WRITING OF ANY FIELD CHANGES, OR CHANGES TO THE APPROVED PLANS, THAT MAY IMPACT INSTALLATION OF WATER FACILITIES, AND SHALL OBTAIN WRITTEN APPROVAL FROM FOWD FOR SUCH CHANGES PRIOR TO CONSTRUCTION. IMPROVEMENT PLANS SHALL BE APPROVED BY THE SACRAMENTO METRO FIRE DEPARTMENT AND ANY NECESSARY EASEMENTS RECORDED PRIOR TO FOWD'S APPROVAL.
- PRE-CONSTRUCTION MEETING** - A PRE-CONSTRUCTION MEETING IS REQUIRED WITH FOWD AND THE CONTRACTOR (AND SACRAMENTO COUNTY INSPECTOR WHEN APPLICABLE) A MINIMUM OF FIVE (5) BUSINESS DAYS PRIOR TO COMMENCING WORK.
- EXISTING FACILITIES AND PRE-WORK SITE CONDITIONS** - THE CONTRACTOR SHALL BE RESPONSIBLE FOR SITE MARKING AND UNDERGROUND SERVICE ALERT (USA) PRIOR TO BEGINNING ANY WORK. THE CONTRACTOR SHALL BE RESPONSIBLE FOR PHYSICALLY LOCATING, INCLUDING POTHOLING, ALL EXISTING UTILITIES AND WATER LINE CONNECTION POINTS TO CONFIRM SIZE, DEPTH, AND MATERIAL TYPE OF EXISTING FACILITIES BEFORE THE START OF WATER FACILITIES INSTALLATION.
- SAFETY** - CONTRACTOR IS SOLELY RESPONSIBLE FOR ANY CURRENTLY APPLICABLE SAFETY LAW AND PRIOR APPROVALS OF ANY JURISDICTIONAL AGENCY, INCLUDING TRAFFIC CONTROL, SLOPING, BORING, AND SHORING. CONTRACTOR IS ALSO RESPONSIBLE FOR PROJECT SITE SAFETY AND FOR PUBLIC SAFETY INCLUDING TRAFFIC CONTROL, 24 HOURS/DAY FOR ALL DAYS, FROM THE NOTICE TO PROCEED THROUGH THE NOTICE OF FINAL COMPLETION.
- PERMITTING** - CONTRACTOR IS RESPONSIBLE TO VERIFY ACQUISITION AND SUBMITTAL OF, AND COMPLIANCE WITH, ANY APPLICABLE PERMITS, INCLUDING BUT NOT LIMITED TO SWPPP, NPDES, ENCROACHMENT PERMITS, AND REQUIRED CERTIFICATES/PERMIT FOR WORKING WITH ASBESTOS CEMENT MATERIALS, FOR EXCAVATION DEEPER THAN 5 FEET, AND FOR ACTIVITIES TO BE PERFORMED IN CONFINED SPACES.
- NOTIFICATIONS** - THE CONTRACTOR SHALL CONTACT FOWD AT (916) 967-5723 A MINIMUM OF TWO (2) BUSINESS DAYS PRIOR TO THE BEGINNING OF WORK OR TO SCHEDULE ANY MEETING.
- TRAFFIC CONTROL** - CONTRACTOR IS RESPONSIBLE FOR PROVIDING TRAFFIC CONTROL PLAN APPROVED BY SACRAMENTO COUNTY (IF NEEDED) AND ANY TRAFFIC CONTROL NECESSARY FOR CONSTRUCTION OF WATER SYSTEM IMPROVEMENTS.
- SUBMITTALS AND BASELINE SCHEDULE** - BEFORE THE WORK PROCEEDS, THE CONTRACTOR SHALL PROVIDE FOWD WITH SUBMITTALS FOR ALL PARTS AND MATERIALS TO BE USED IN CONSTRUCTION. ALL SUBMITTALS MUST BE APPROVED BY FOWD PRIOR TO INSTALLATION. AWWA AND/OR NSF CERTIFICATIONS ARE REQUIRED FOR ALL WATER MATERIAL. CONTACT FOWD TWO BUSINESS DAYS TO ARRANGE FOR REVIEW AND INSPECTION OF MATERIALS PRIOR TO INSTALLATION. CONTRACTOR SHALL PROVIDE A BASELINE SCHEDULE INCLUDING MAJOR ACTIVITIES FROM BEGINNING OF THE PROJECT TILL THE END. SCHEDULE TO BE UPDATED PER FOWD DIRECTION.
- FEES** - IF APPLICABLE, THE CONTRACTOR/APPLICANT MUST PAY ALL ASSOCIATED WATER FEES PRIOR TO THE APPROVEMENT PLAN APPROVAL BY FOWD.
- SURVEYING AND MONUMENTS PROTECTION** - THE CONTRACTOR IS RESPONSIBLE FOR ALL REQUIRED STAKING, SHOWING THE LOCATION AND GRADES FOR INSTALLING ALL WATER FACILITIES PRIOR TO THEIR INSTALLATION. THE CONTRACTOR SHALL BE RESPONSIBLE FOR PROTECTING AND MAINTAINING ALL SURVEY MONUMENTS AND RESTORING ANY MONUMENTS DAMAGED BY CONTRACTOR.
- GRADING** - WATER MAINS, SERVICES, METERS, AND METER BOXES SHALL NOT BE INSTALLED UNTIL THE FINISHED GRADE IS ESTABLISHED. THE CONTRACTOR IS FULLY RESPONSIBLE FOR ANY WATER FACILITIES ADJUSTMENTS DUE TO ERRORS IN ESTABLISHING FINISHED GRADE.
- WATER MAIN LOCATION AND EASEMENT** - WATER MAINS SHALL BE INSTALLED WITHIN PUBLIC STREET RIGHT OF WAY (ROW) AND SHALL BE LOCATED 3 FEET FROM THE LIP OF GUTTER (UNDER STREET PAVEMENT). WATER MAINS INSTALLED ON PRIVATE PROPERTY/ROAD SHALL BE PLACED AT THE CENTERLINE OF A 20-FOOT WIDE WATER EASEMENT, OR AS APPROVED BY FOWD, BUT NEVER LESS THAN 10 FEET WIDE. EASEMENT(S) MUST BE ADOPTED AND RECORDED WITH SACRAMENTO COUNTY BEFORE WATER SERVICE IS TURNED ON. PLANTING OF TREES AND SHRUBS WITHIN WATER EASEMENTS FOR EXISTING OR PROPOSED FUTURE WATER FACILITIES SHALL BE AVOIDED. FOWD RESERVES THE RIGHTS TO REQUIRE REMOVAL (AT CONTRACTOR EXPENSE) OF TREES AND SHRUBS OR ANY OTHER OBSTACLES THAT MAY IMPACT, OR HAVE IMPACTED, WATER FACILITIES INSTALLATION, MAINTENANCE, OR OPERATIONS.
- TRACER WIRE & CAUTION TAPE** - ALL WATER MAINS, HYDRANT RUNS, AND WATER SERVICE 3-INCH AND LARGER IN SIZE SHALL HAVE #10 AWG, CONTINUOUS SINGLE STRAND COATED COPPER TRACER WIRE AND 12" WIDE NON-DETECT BLUE TAPE WITH WORDS "CAUTION: BURIED WATER LINE BELOW" 12"-18" ON ALL WATER PIPING ON SEEDING PER FOWD STD.
- PROTECTION OF WATER MAINS INSTALLATION AND VALVES OPERATION** - CONTRACTOR MUST SEAL PIPE ENDS WATERTIGHT AT END OF EACH WORKDAY WHEN LAYING WATER PIPE. CONTRACTOR SHALL NOT OPERATE FLOW VALVES.
- WATER SERVICE** - EACH SINGLE FAMILY OR CONDO PARCEL SHALL HAVE A SEPARATE SERVICE TAP. APARTMENT AND OTHER COMMERCIAL DEVELOPMENT ON ONE PARCEL HAVE THE OPTIONS: A) TO HAVE ONE OR TWO MASTER METERS THAT PROVIDES DOMESTIC WATER TO THE ENTIRE PARCEL. B) HAVE DEDICATED DOMESTIC WATER SERVICES TO INDIVIDUAL BUILDINGS, APARTMENT AND OTHER COMMERCIAL DEVELOPMENT SHALL HAVE A DEDICATED IRRIGATION SERVICE. APARTMENT AND OTHER COMMERCIAL DEVELOPMENT SHALL HAVE A DEDICATED FIRE SERVICE(S) AS REQUIRED BY THE SACRAMENTO METRO FIRE DEPARTMENT ON THE SAME PARCEL OF DIFFERENT CLASSIFICATIONS (DOMESTIC, IRRIGATION, AND FIRE) SHALL NOT BE LOOPED TOGETHER. ALL WATER SERVICES SERVING COMMERCIAL, GOVERNMENTAL, PUBLIC, IRRIGATION PRIVATE FIRE PROTECTION AND INDUSTRIAL FACILITIES WITH FIRE SUPPRESSION SYSTEMS, SHALL BE EQUIPPED WITH FOWD APPROVED BACKFLOW DEVICES. PRIVATE WATER SERVICES SHALL NOT CROSS PARCEL LINES. WATER METER SHALL BE INSTALLED PRIOR TO ACCEPTANCE AND ACTIVATION OF WATER SYSTEM.
- WATER SERVICES LOCATIONS** - ALL WATER SERVICES SHALL BE SET THREE (3) FEET FROM ADJACENT SIDE PROPERTY LINES WITHIN STREET ROW, PUE, OR DEDICATED WATER EASEMENT ON THE CORRECT LOT SITE UNLESS OTHERWISE APPROVED BY FOWD. CONTRACTOR SHALL STAKE LOT LINES PRIOR TO INSTALLATION AND AT THE TIME OF FINAL INSPECTION. SERVICES ARE TO BE INSTALLED SO PLUMBERS NEED NOT DISTURB THE METER BOX DURING CUSTOMER HOOK-UP. WATER BOXES THAT ARE TEMPORARILY REMOVED SHALL BE REPLACED BY THE CONTRACTOR AT THEIR EXPENSE. INSTALLATION OF WATER METER BOXES WITHIN SIDEWALKS OR DRIVEWAYS ARE NOT ALLOWED UNLESS APPROVED BY FOWD.
- BACKFLOW PROTECTION** - BACKFLOW PREVENTION DEVICE SHALL BE REDUCED PRESSURE PRINCIPLE (RP) DEVICES FOR DOMESTIC AND IRRIGATION SERVICES, AND REDUCED PRINCIPAL DETECTOR CHECK ASSEMBLY (RPDA) FOR DEDICATED FIRE SERVICES. RP/PPDA DEVICES SHALL BE INSTALLED BY CONTRACTOR IN ACCORDANCE WITH FOWD APPLICABLE STANDARDS AND TESTED AND CERTIFIED BY FOWD FOR THE FIRST TIME PRIOR TO OBTAINING WATER SERVICE. MAINTENANCE AND ANNUAL CERTIFICATION OF THE RP/PPDA DEVICE ARE THE PROPERTY OWNER'S RESPONSIBILITY. TYPE OF RP/PPDA DEVICES SHALL BE APPROVED BY FOWD. RP DEVICES SHALL BE INSTALLED WITHIN FIVE (5) FEET FROM THE METER BOX AND RPDA SHALL BE INSTALLED WITHIN 5 FEET FROM EDGE OF RIGHT OF WAY FOR FIRE SERVICE, WITH NO TEES OR CROSS CONNECTIONS BETWEEN THE WATER METER AND A RP/PPDA DEVICE.
- SANITARY SEWER AND STORM DRAIN PROXIMITY** - A MINIMUM OF 10 FT HORIZONTAL AND 1 FT VERTICAL SEPARATION BETWEEN WATER AND SANITARY SEWER FACILITIES, AND A MINIMUM OF 4 FT HORIZONTAL AND 1 FT VERTICAL SEPARATION BETWEEN WATER AND STORM FACILITIES ARE REQUIRED. IF REQUIRED SEPARATION CANNOT BE MAINTAINED, A HIGHER CLASS OF PIPE MATERIAL AND POSSIBLE SLEEVE FOR THE PIPE INSTALLATION WITH FOWD APPROVED INSTALLATION DETAIL IS REQUIRED. ANY WATER MAIN NEEDING TO BE ROUTED UNDER SEWER REQUIRES SWRC-ODW APPROVAL PRIOR TO INSTALLATION.
- DRY UTILITIES PROXIMITY** - A MINIMUM OF 4 FT HORIZONTAL AND 1 FT VERTICAL SEPARATION BETWEEN WATER AND ALL DRY UTILITIES INCLUDING GAS IS REQUIRED. VARIANCES REQUIRE FOWD APPROVAL.
- BACKFILLING AND COMPACTION** - NATIVE BACKFILL WILL NOT BE ALLOWED IN TRENCHES CONTAINING PUBLIC WATER FACILITIES. TRENCH FOR ALL PUBLIC WATER MAINS/SERVICES LOCATED WITHIN AN EXISTING OR PROPOSED ROW, PUE, OR DEDICATED WATER EASEMENTS, SHALL CONFORM TO FOWD SPECIFICATIONS, FOWD'S STANDARD DRAWING #9, AND ALL SACRAMENTO COUNTY REQUIREMENTS AS THEY APPLY. A MINIMUM OF 36-INCH COVER OVER WATER MAINS AND A MINIMUM OF 24-INCH COVER OVER WATER SERVICES ARE REQUIRED UNLESS OTHERWISE APPROVED BY FOWD. UTILITY SAND BEDDING SHALL BE MINIMUM OF 6" BELOW BASE AND 12" ABOVE PIPE. BEDDING FOUNDATION SHALL PROVIDE UNIFORM SUPPORT OF PIPE, WITH BELL ENDS EXCAVATED PER MANUFACTURER'S RECOMMENDATION. EACH LIFT SHALL BE COMPACTED TO 90%.
- PAVING RESTORATION** - SHALL BE PER SACRAMENTO COUNTY APPLICABLE STANDARD DRAWINGS AND REQUIREMENTS.
- HYDROSTATIC TESTING** - THE CONTRACTOR SHALL PROVIDE A PASSING HYDROSTATIC TEST FOR ALL NEW PIPES AND WATER APPURTENANCES IN ACCORDANCE WITH FOWD STANDARD SPECIFICATIONS OR THE MOST RECENT AWWA STANDARD FOR METHOD AND MATERIALS USED. THE TESTING MUST BE WITNESSED AND APPROVED BY AN AUTHORIZED FOWD REPRESENTATIVE. NOTIFICATION FOR SCHEDULING OF TEST MUST BE PROVIDED A MINIMUM OF TWO WORKING DAYS PRIOR TO TESTING AND MUST BE CONDUCTED MON-THUR.
- DISINFECTION AND BACTERIOLOGICAL SAMPLING** - ALL NEW WATER FACILITIES SHALL BE DISINFECTED IN ACCORDANCE WITH CURRENT AWWA STANDARD AND FOWD STANDARD SPECIFICATIONS. FOWD COLLECTS SAMPLES FOR BACTERIOLOGICAL TESTING AND MUST BE CONTACTED A MINIMUM OF TWO WORKING DAYS PRIOR TO NEEDED SAMPLING.
- MAINS AND SERVICES SHUTDOWN** - THE CONTRACTOR SHALL CONTACT FOWD INSPECTOR AND/OR FOWD OFFICE A MINIMUM OF THREE (3) WORKING DAYS PRIOR TO ANY WATER MAIN/SERVICE SHUTDOWN REQUEST. NECESSARY SHUTDOWNS ARE TO BE COMPLETED BY FOWD AUTHORIZED STAFF OR REPRESENTATIVE(S) ONLY.
- INSPECTION** - FOWD INSPECTOR WILL INSPECT INSTALLATION OF ALL PUBLIC WATER FACILITIES. IF AFTER ANY INSTALLATION, OR FINAL INSPECTION, FOWD DETERMINES THAT THE JOB IS NOT COMPLETE OR NOT COMPLETED IN ACCORDANCE WITH THE PROJECT DOCUMENTS OR FOWD STANDARDS, THE CONTRACTOR WILL HAVE 15 WORKING DAYS TO COMPLETE THE WORK TO FOWD'S SATISFACTION. THE CONTRACTOR MAY BE CHARGED FOR RE-INSPECTION. WATER SYSTEM WILL NOT BE ACTIVATED UNTIL ALL DEFICIENCIES HAVE BEEN CORRECTED AND THE SYSTEM IS ACCEPTED BY FOWD.
- WARRANTY** - CONTRACTOR SHALL PROVIDE MAINTENANCE BOND AND GUARANTEE ALL WORK FOR A PERIOD OF ONE (1) YEAR FROM THE DATE THE NEW WATER FACILITIES ACCEPTED BY FOWD AGAINST DAMAGES OR FAILURES FROM ANY CAUSE.
- SALVAGE AND DISPOSAL** - CONTRACTOR IS RESPONSIBLE FOR REMOVAL AND DISPOSAL OF ALL SALVAGE PIPE, AS WELL AS ANY FITTINGS OR OTHER RELATED MATERIALS GENERATED FROM INSTALLATION AND TIE-IN TO FOWD WATER LINES AND COSTS ASSOCIATED. DISTURBANCE OF ASBESTOS CEMENT PIPES (ACP) IS REGULATED UNDER CAL/OSHA TITLE 8, SECTION 1529 AND CONTRACTOR SHALL COMPLY WITH ALL THEREIN. CONTRACTOR MUST SUBMIT TO FOWD A CERTIFICATE OF DISPOSAL TO VERIFY ANY ACP WASTE WAS PROPERLY DISPOSED OF, ANY PORTION OF ACP TO BE ABANDONED IN PLACE MUST BE LEFT INTACT AND NON-FRAGILE.

INSTALLATION CHART	
QUANTITY	DESCRIPTION
1,810 ±LF	12" DIP WATER MAIN ON NEW YORK AVE
55 ±LF	8" DIP WATER MAIN
19 EA	1" WATER SERVICES
3 EA	1.5" WATER SERVICES
2 EA	2" WATER SERVICES
4 EA	6" FIRE HYDRANT
2 EA	1" AVRV

RETIREMENT CHART	
QUANTITY	DESCRIPTION
1,780 ±LF	12" STEEL WATER MAIN
85 ±LF	8" & 6" WATER MAIN (VARIOUS TYPES)
23 EA	WATER SERVICE (VARIOUS SIZES)
4 EA	FIRE HYDRANT (VARIOUS SIZES)

DIRECTOR DIVISIONS (X)	
BOARD OF DIRECTORS	
CHRIS PETERSEN	PRESIDENT (1)
MARK DOLBY	VICE PRESIDENT (3)
MICHAEL MCRAE	DIRECTOR (2)
RANDY MARX	DIRECTOR (4)
MISHA SARKOVICH	DIRECTOR (5)
<b>FOWD GENERAL MANAGER - TOM R. GRAY</b>	
APPROVED BY:	
FAIR OAKS WATER DISTRICT	DATE
EXPIRES 1 YEAR FROM DATE OF SIGNATURE	

REVIEWED BY:	DATE:	PREPARED BY: A.SHAFAQ	FAIR OAKS WATER DISTRICT 10326 FAIR OAKS BLVD, FAIR OAKS, CA 95628, (916) 967-5723			DATE:	DATE		SHEET 1 OF 7 SHEETS PROJECT NUMBER C24TDNYA
REVIEWED BY:	DATE:	DRAWN BY: A.SHAFAQ	12" WATER MAIN REPLACEMENT PLAN ON NEW YORK AVENUE (PHASE I)			SCALE:	N/A		
REVIEWED BY:	DATE:	CHECKED BY: P.SIEBENSCHON	COVER SHEET			HORIZ:	N/A		
		DATE: 5/7/2024	REV.	DATE	DESCRIPTION	APP.	VER.:		



**INSTALLATION NOTES:**

- 1 ABANDON EX. W.S. PER FOWD STD. SPEC.
- 2 INSTALL NEW WATER SERVICE LINE FROM PROPOSED (P) WATER MAIN AND CONNECT TO EXISTING (EX.) METER SETTER PER FOWD STD-7. REPLACE EX. METER BOX WITH A CONCRETE BOX AND STEEL LID MARKED "WATER" WITH A 2" CORE HOLE FOR ANTENNA. SERVICE CONNECTION SHALL BE MADE WITH MINIMAL SERVICE DISRUPTION.
- 3 ABANDON EX. HYDRANT & BOLLARDS PER FOWD STD. SPEC. AND SALVAGE HYDRANT HEAD TO THE FOWD.
- 4 CONTRACTOR TO ABANDON EX. VALVES AND VALVE BOXES PER SACRAMENTO COUNTY STANDARD (TYP).
- 5 ALL WATER SERVICES RUN OVER AT CROSSING WITH SS MAIN.
- 6 ALL DIMENSIONS PROVIDED ON THIS PLAN ARE IN FEET UNLESS OTHERWISE NOTE. PIPE DIAMETERS ARE IN INCHES.

**NOTE:**  
DUCTILE IRON PIPE GASKETS MUST BE FIELD LOK 350, OR EQUAL, PER AWWA C111

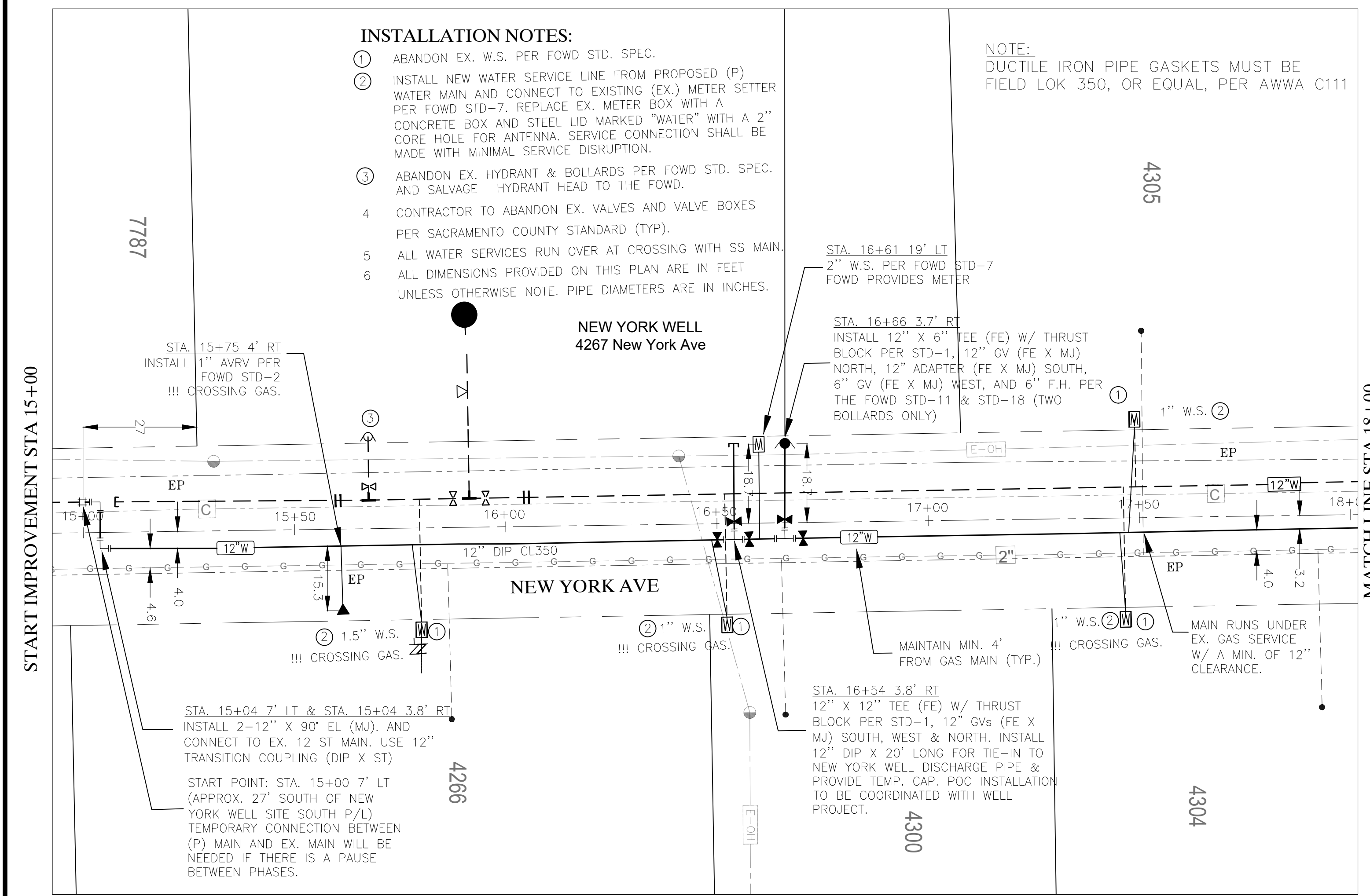

MATCH LINE STA 18+00  
SEE THIS SHEET

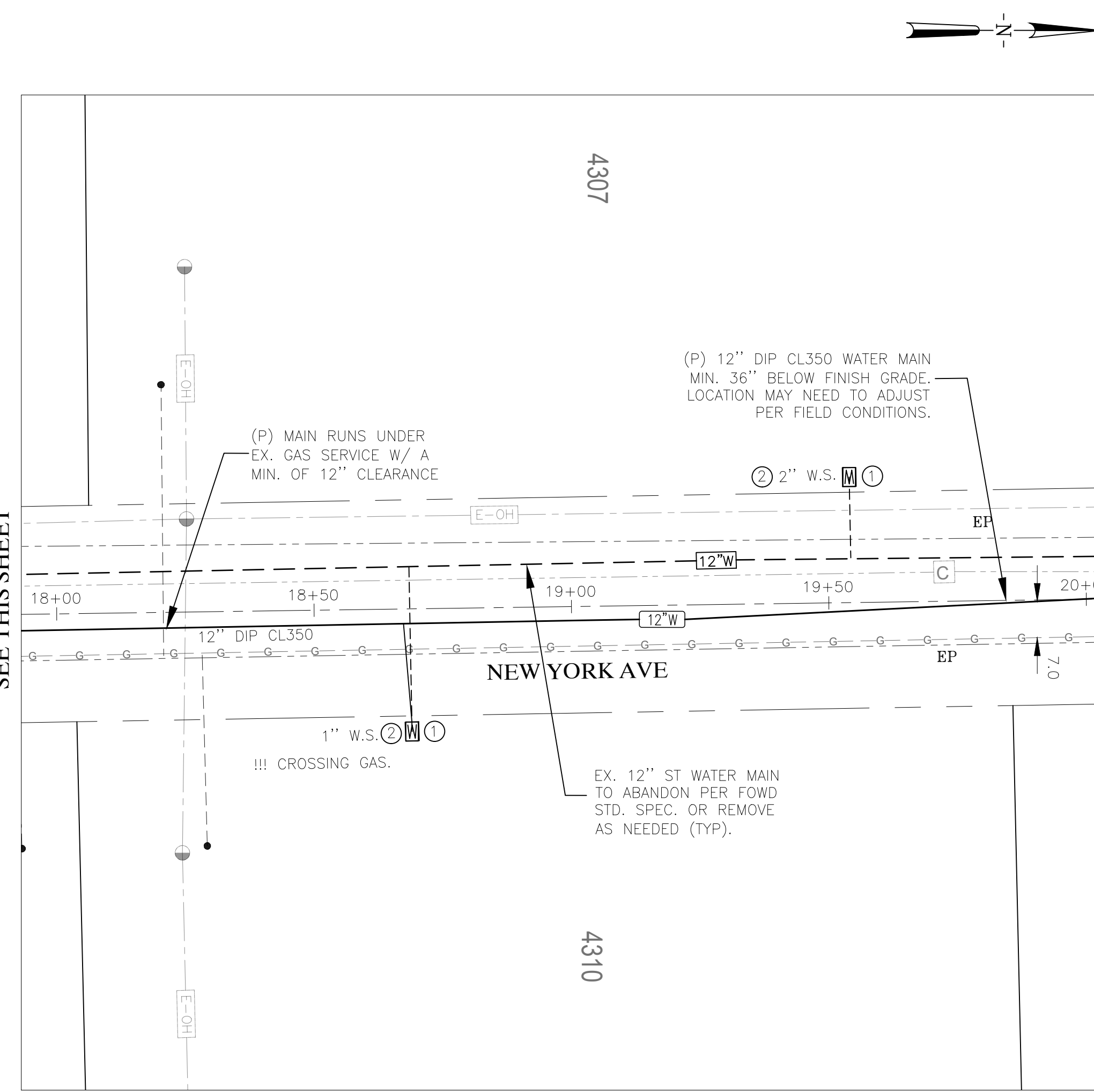

MATCH LINE STA 20+00  
SEE SHEET 3 (SH-3)

**STORM DRAIN NOTE:**

DRAINAGE INFORMATION AS SHOWN ON THIS PLAN ARE FROM SACRAMENTO COUNTY DEPARTMENT OF WATER RESOURCES, DRAINAGE FACILITY MAP #356/206 & 358/206.

PER SACRAMENTO COUNTY WATER RESOURCES: MAINTAIN 18" (INCHES) OF VERTICAL SEPARATION BETWEEN EX. STORM DRAIN AND (P) WATER MAIN AT ALL CROSSINGS (TYP). MECHANICAL INVERTS FOR WATER MAINS SHALL BE INSTALLED PER FOWD STD-17 WITH MIN. 18" OF VERTICAL SEPARATION.

**EXISTING FACILITIES NOTE:**

THE TYPES, LOCATIONS, SIZES AND/OR DEPTHS OF EXISTING EX. UTILITIES WERE OBTAINED FROM OUTSIDE AGENCY AS-BUILTS AND MAY VARY IN RELIABILITY. THE CONTRACTOR SHALL VERIFY AT ALL UTILITY CROSSINGS TO DETERMINE THE ACTUAL LOCATIONS, SIZE, TYPE, AND DEPTHS OF EX. UTILITIES. PRIOR TO COMMENCING CONSTRUCTION ACTIVITIES, CONTRACTOR SHALL NOTIFY FAIR OAKS WATER DISTRICT INSPECTOR TO DETERMINE ANY POSSIBLE CONFLICTS WITH INSTALLATION OF WATER MAIN AND APPURTENANCES. (TYP)

**SANITARY SEWER NOTE:**

MAINTAIN 12" MINIMUM VERTICAL SEPARATION AT SANITARY SEWER CROSSINGS. PER CSD-1, A MINIMUM OF TEN (10) FEET OF HORIZONTAL (WALL-TO-WALL) CLEARANCE SHALL BE MAINTAINED BETWEEN PARALLEL SANITARY SEWER AND WATER DISTRIBUTION MAINS PER FOWD STANDARD SPEC. UNLESS OTHERWISE APPROVED. WATER CROSSINGS WITH SEWER MAINS LATERALS MUST BE DONE AS CLOSE TO PERPENDICULAR AS PRACTICABLE. CROSSING WITH AN ANGLE LESS THAN 45° SHALL NOT BE CONSTRUCTED.

**WATER FACILITIES INSTALLATION NOTE:**

PROPOSED (P) WATER FACILITIES CROSSING WITH EXISTING UTILITIES AT MULTIPLE LOCATIONS WITHIN THE PROJECT LIMITS WHICH MAY REQUIRE (P) WATER FACILITIES TO BE INSTALLED DEEPER THAN REGULAR DEPTH OF 36" FROM FINISH GRADE. CONTRACTOR TO POTHOLE (AT CONTRACTOR EXPENSE) EVERY CROSSING PRIOR TO START OF TRENCHING.

**EROSION/SEDIMENT CONTROL NOTE:**

PER SAC COUNTY WATER RESOURCES: SEE SHEET 6 ATTACHED WITH THESE PLANS FOR EROSION/SEDIMENT CONTROL MEASURES WITHIN PROJECT LIMITS.

**FINAL PLAN**  
**PIPELINE IMPROVEMENTS**

NEW YORK AVE. - STA. 15+00 TO STA. 20+00

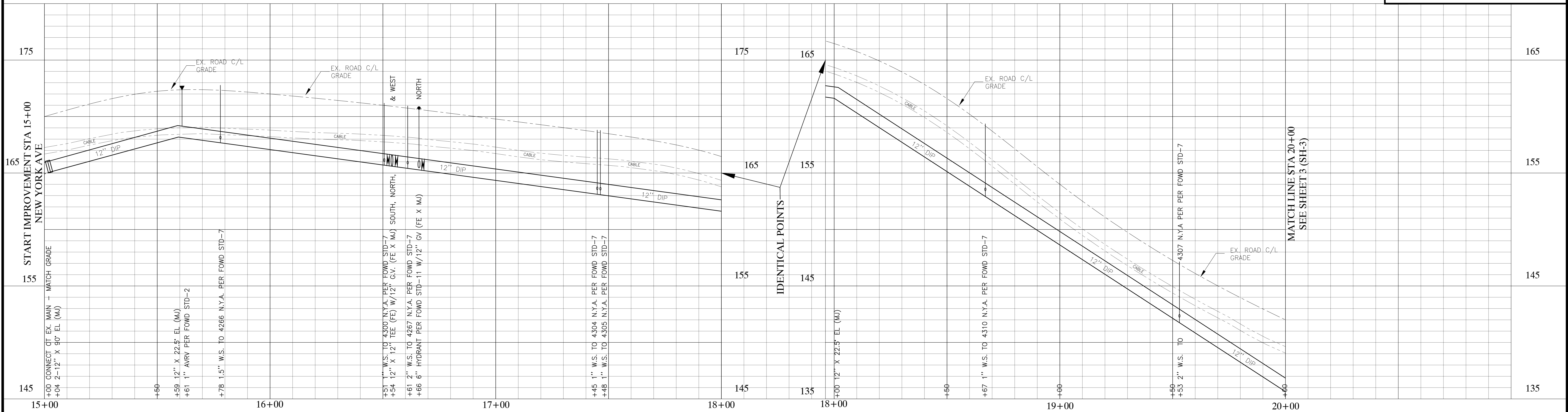

MATCH LINE STA 20+00  
SEE SHEET 3 (SH-3)

REVIEWED BY:	DATE:
REVIEWED BY:	DATE:
REVIEWED BY:	DATE:

DESIGNED BY:	A. SHAFIQ
DRAWN BY:	A. SHAFIQ
CHECKED BY:	P. SIEBENSOHN
DATE:	5/7/2024

REV.	DATE	DESCRIPTION	APP.

**FAIR OAKS WATER DISTRICT**  
 10326 FAIR OAKS BLVD. FAIR OAKS, CA 95628 (916) 967-5723  
**12" WATER MAIN REPLACEMENT PLAN ON NEW YORK AVENUE (PHASE I)**  
**PLAN-PROFILE**

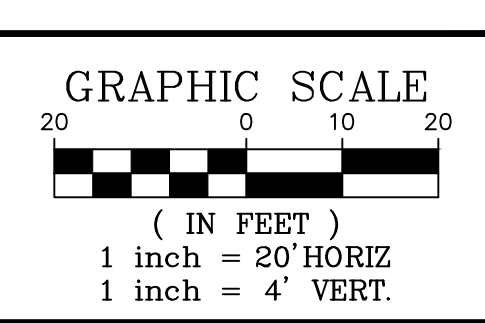

  
**FAIR OAKS WATER DISTRICT**  
 SHEET **2**  
 OF **7** SHEETS  
 PROJECT NUMBER **C24TDNYA**

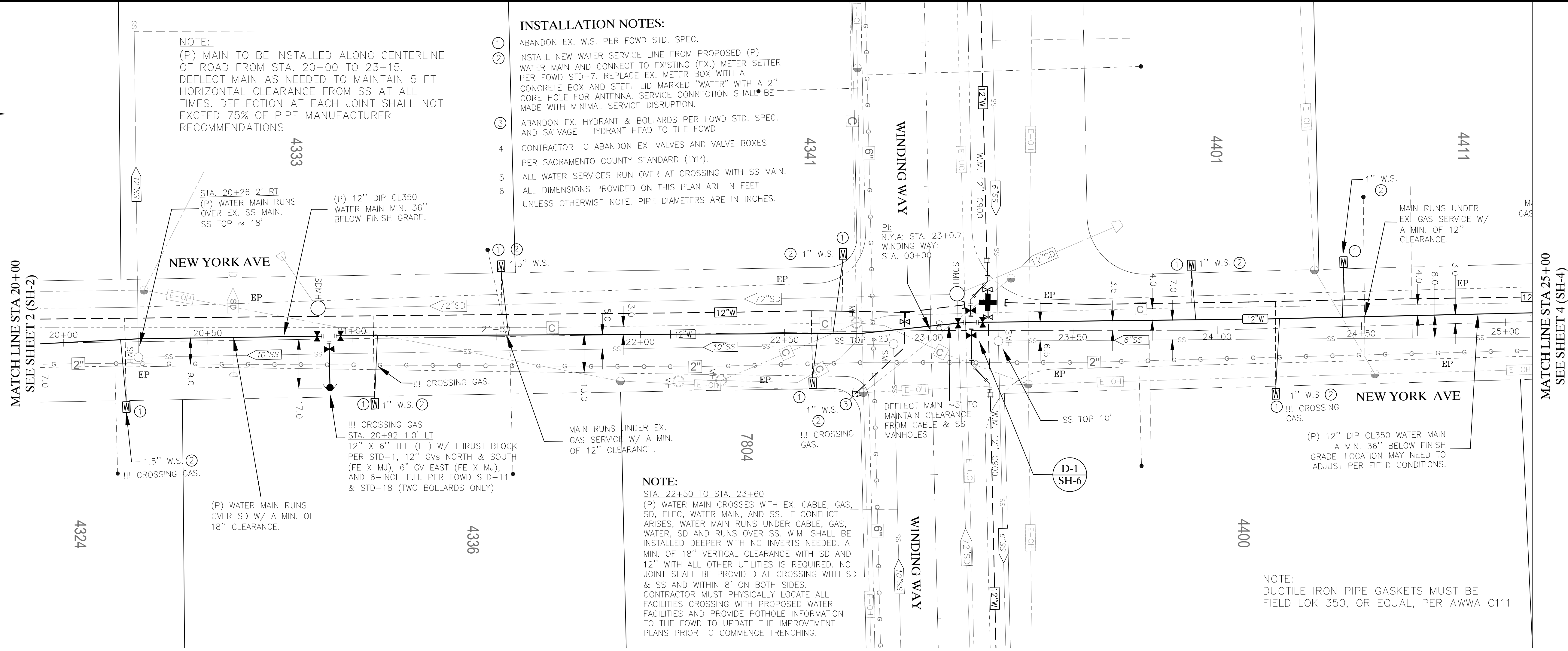
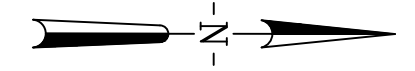

**STORM DRAIN NOTE:**  
DRAINAGE INFORMATION AS SHOWN ON THIS PLAN ARE FROM SACRAMENTO COUNTY DEPARTMENT OF WATER RESOURCES, DRAINAGE FACILITY MAP #356/206 & 358/206.

PER SACRAMENTO COUNTY WATER RESOURCES: MAINTAIN 18" (INCHES) OF VERTICAL SEPARATION BETWEEN EX. STORM DRAIN AND (P) WATER MAIN AT ALL CROSSINGS (TYP). MECHANICAL INVERTS FOR WATER MAINS SHALL BE INSTALLED PER FOWD STD-17 WITH MIN. 18" OF VERTICAL SEPARATION.

**EXISTING FACILITIES NOTE:**  
THE TYPES, LOCATIONS, SIZES AND/OR DEPTHS OF EXISTING EX. UTILITIES WERE OBTAINED FROM OUTSIDE AGENCY AS-BUILTS AND MAY VARY IN RELIABILITY. THE CONTRACTOR SHALL POTHOLE AT ALL UTILITY CROSSINGS TO DETERMINE THE ACTUAL LOCATIONS, SIZE, TYPE, AND DEPTHS OF EX. UTILITIES. PRIOR TO COMMENCING CONSTRUCTION ACTIVITIES, CONTRACTOR SHALL NOTIFY FAIR OAKS WATER DISTRICT INSPECTOR TO DETERMINE ANY POSSIBLE CONFLICTS WITH INSTALLATION OF WATER MAIN AND APPURTENANCES. (TYP)

**SANITARY SEWER NOTE:**  
MAINTAIN 12" MINIMUM VERTICAL SEPARATION AT SANITARY SEWER CROSSINGS. PER CSD-1. A MINIMUM OF TEN (10') FEET OF HORIZONTAL (WALL-TO-WALL) CLEARANCE SHALL BE MAINTAINED BETWEEN PARALLEL SANITARY SEWER AND WATER DISTRIBUTION MAINS PER FOWD STANDARD SPEC. UNLESS OTHERWISE APPROVED. WATER CROSSINGS WITH SEWER MAINS LATERALS MUST BE DONE AS CLOSE TO PERPENDICULAR AS PRACTICABLE. CROSSING WITH AN ANGLE LESS THAN 45° SHALL NOT BE CONSTRUCTED.

**IMPORTANT NOTE:**  
PROPOSED (P) WATER FACILITIES CROSSING WITH EXISTING UTILITIES AT MULTIPLE LOCATIONS WITHIN THE PROJECT WHICH MAY REQUIRE (P) WATER FACILITIES TO BE INSTALLED DEEPER THAN REGULAR DEPTH OF 36" FROM FINISH GRADE. CONTRACTOR TO POTHOLE (AT CONTRACTOR EXPENSE) EVERY CROSSING PRIOR TO START OF TRENCHING.

**EROSION/SEDIMENT CONTROL NOTE:**  
PER SAC COUNTY WATER RESOURCES: SEE SHEET 6 ATTACHED WITH THESE PLANS FOR EROSION/SEDIMENT CONTROL MEASURES WITHIN PROJECT LIMITS.

NEW YORK AVE. - STA 20+00 TO STA. 25+00

**FINAL PLAN**  
**PIPELINE IMPROVEMENTS**

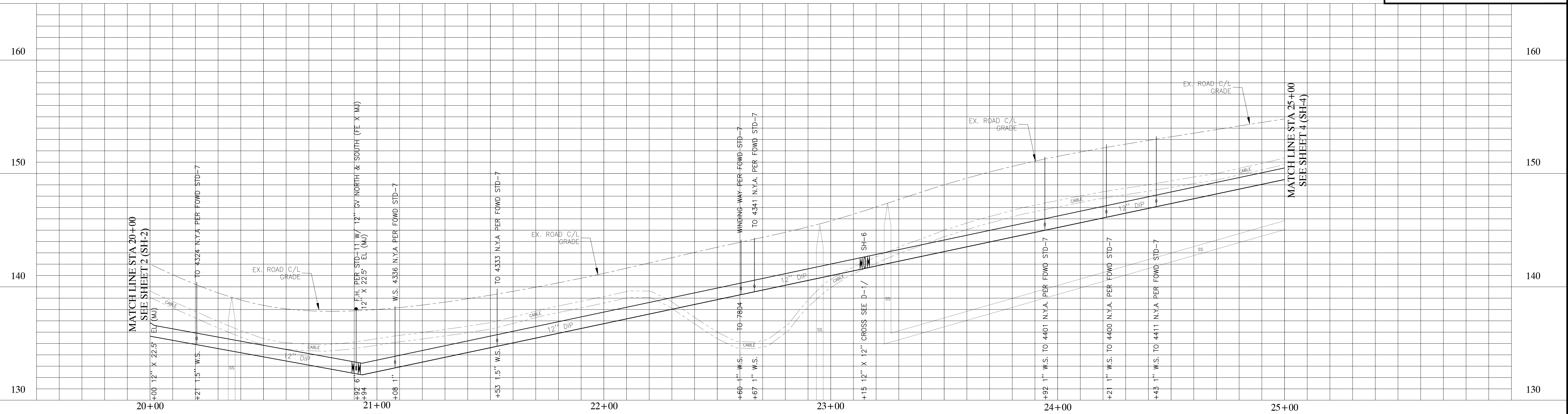

REVIEWED BY:	DATE:	DESIGNED BY:			
REVIEWED BY:	DATE:	DRAWN BY:	A. SHAFaq		
REVIEWED BY:	DATE:	CHECKED BY:	P. SIEBENSohn		
	DATE:	DATE:	5/7/2024	REV.	DATE
				DESCRIPTION	APP.

FAIR OAKS WATER DISTRICT  
10326 FAIR OAKS BLVD. FAIR OAKS, CA 95628 (916) 967-5723  
**12" WATER MAIN REPLACEMENT PLAN ON NEW YORK AVENUE (PHASE I)**  
**PLAN-PROFILE**

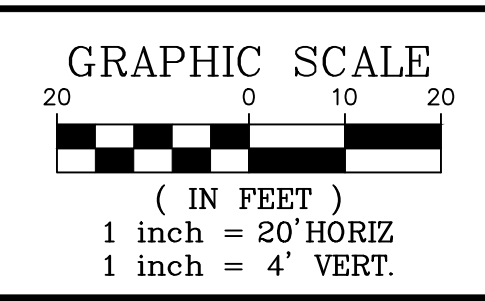

SHEET 3  
OF 7 SHEETS  
PROJECT NUMBER C24TDNYA

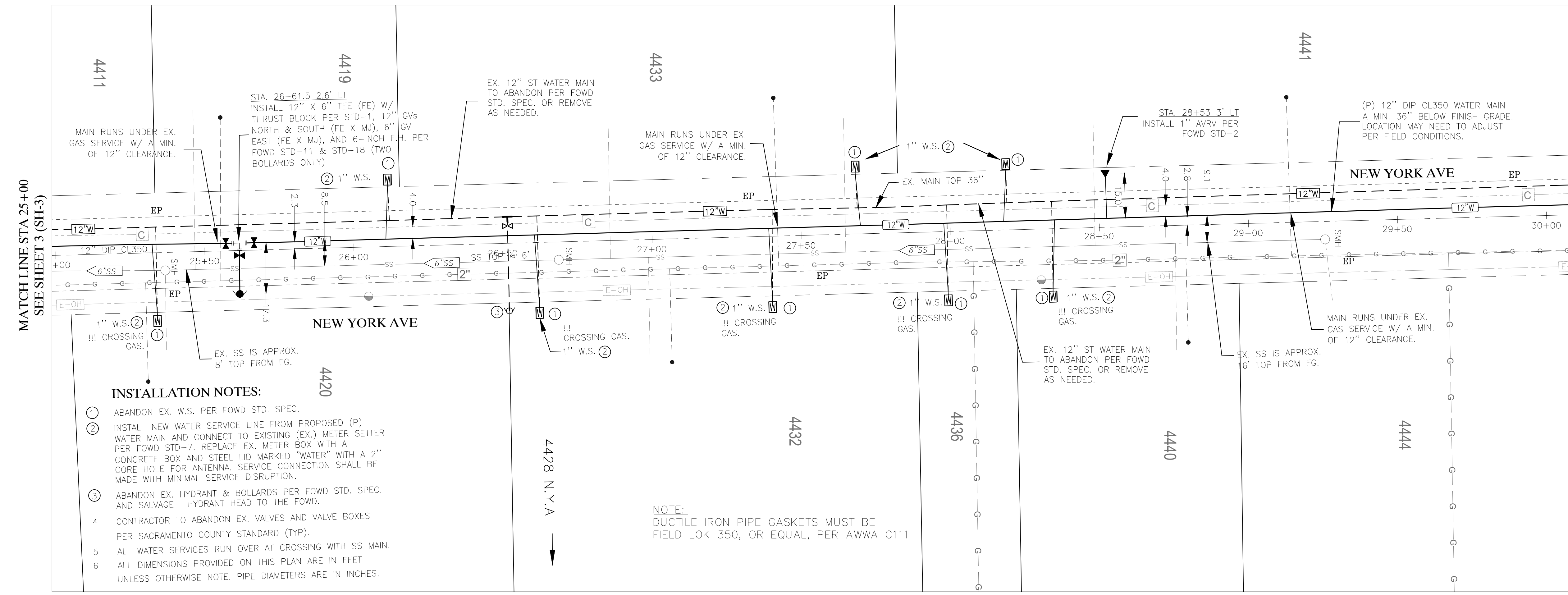
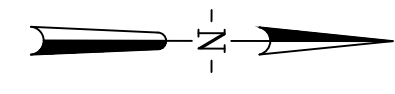

MATCH LINE STA 25+00  
SEE SHEET 3 (SH-3)

MATCH LINE STA 30+00  
SEE SHEET 5 (SH-5)

- INSTALLATION NOTES:**
- 1 ABANDON EX. W.S. PER FOWD STD. SPEC.
  - 2 INSTALL NEW WATER SERVICE LINE FROM PROPOSED (P) WATER MAIN AND CONNECT TO EXISTING (EX.) METER SETTER PER FOWD STD-7. REPLACE EX. METER BOX WITH A CONCRETE BOX AND STEEL LID MARKED "WATER" WITH A 2" CORE HOLE FOR ANTENNA. SERVICE CONNECTION SHALL BE MADE WITH MINIMAL SERVICE DISRUPTION.
  - 3 ABANDON EX. HYDRANT & BOLLARDS PER FOWD STD. SPEC. AND SALVAGE HYDRANT HEAD TO THE FOWD.
  - 4 CONTRACTOR TO ABANDON EX. VALVES AND VALVE BOXES PER SACRAMENTO COUNTY STANDARD (TYP).
  - 5 ALL WATER SERVICES RUN OVER AT CROSSING WITH SS MAIN.
  - 6 ALL DIMENSIONS PROVIDED ON THIS PLAN ARE IN FEET UNLESS OTHERWISE NOTE. PIPE DIAMETERS ARE IN INCHES.

**NOTE:**  
DUCTILE IRON PIPE GASKETS MUST BE FIELD LOK 350, OR EQUAL, PER AWWA C111

**STORM DRAIN NOTE:**  
DRAINAGE INFORMATION AS SHOWN ON THIS PLAN ARE FROM SACRAMENTO COUNTY DEPARTMENT OF WATER RESOURCES, DRAINAGE FACILITY MAP #356/206 & 358/206.  
  
PER SACRAMENTO COUNTY WATER RESOURCES: MAINTAIN 18" (INCHES) OF VERTICAL SEPARATION BETWEEN EX. STORM DRAIN AND (P) WATER MAIN AT ALL CROSSINGS (TYP). MECHANICAL INVERTS FOR WATER MAINS SHALL BE INSTALLED PER FOWD STD-17 WITH MIN. 18" OF VERTICAL SEPARATION.

**EXISTING FACILITIES NOTE:**  
THE TYPES, LOCATIONS, SIZES AND/OR DEPTHS OF EXISTING EX. UTILITIES WERE OBTAINED FROM OUTSIDE AGENCY AS-BUILTS AND MAY VARY IN RELIABILITY. THE CONTRACTOR SHALL POLOLE AT ALL UTILITY CROSSINGS TO DETERMINE THE ACTUAL LOCATIONS, SIZE, TYPE, AND DEPTHS OF EX. UTILITIES. PRIOR TO COMMENCING CONSTRUCTION ACTIVITIES, CONTRACTOR SHALL NOTIFY FAIR OAKS WATER DISTRICT INSPECTOR TO DETERMINE ANY POSSIBLE CONFLICTS WITH INSTALLATION OF WATER MAIN AND APPURTENANCES. (TYP)

**SANITARY SEWER NOTE:**  
MAINTAIN 12" MINIMUM VERTICAL SEPARATION AT SANITARY SEWER CROSSINGS. PER CSD-1. A MINIMUM OF TEN (10') FEET OF HORIZONTAL (WALL-TO-WALL) CLEARANCE SHALL BE MAINTAINED BETWEEN PARALLEL SANITARY SEWER AND WATER DISTRIBUTION MAINS PER FOWD STANDARD SPEC. UNLESS OTHERWISE APPROVED. WATER CROSSINGS WITH SEWER MAINS LATERALS MUST BE DONE AS CLOSE TO PERPENDICULAR AS PRACTICABLE. CROSSING WITH AN ANGLE LESS THAN 45° SHALL NOT BE CONSTRUCTED.

**IMPORTANT NOTE:**  
PROPOSED (P) WATER FACILITIES CROSSING WITH EXISTING UTILITIES AT MULTIPLE LOCATIONS WITHIN THE PROJECT WHICH MAY REQUIRE (P) WATER FACILITIES TO BE INSTALLED DEEPER THAN REGULAR DEPTH OF 36" FROM FINISH GRADE. CONTRACTOR TO POLOLE (AT CONTRACTOR EXPENSE) EVERY CROSSING PRIOR TO START OF TRENCHING.

**EROSION/SEDIMENT CONTROL NOTE:**  
PER SAC COUNTY WATER RESOURCES; SEE SHEET 6 ATTACHED WITH THESE PLANS FOR EROSION/SEDIMENT CONTROL MEASURES WITHIN PROJECT LIMITS.

**FINAL PLAN**  
**PIPELINE IMPROVEMENTS**

NEW YORK AVE. - STA 25+00 TO STA. 30+00

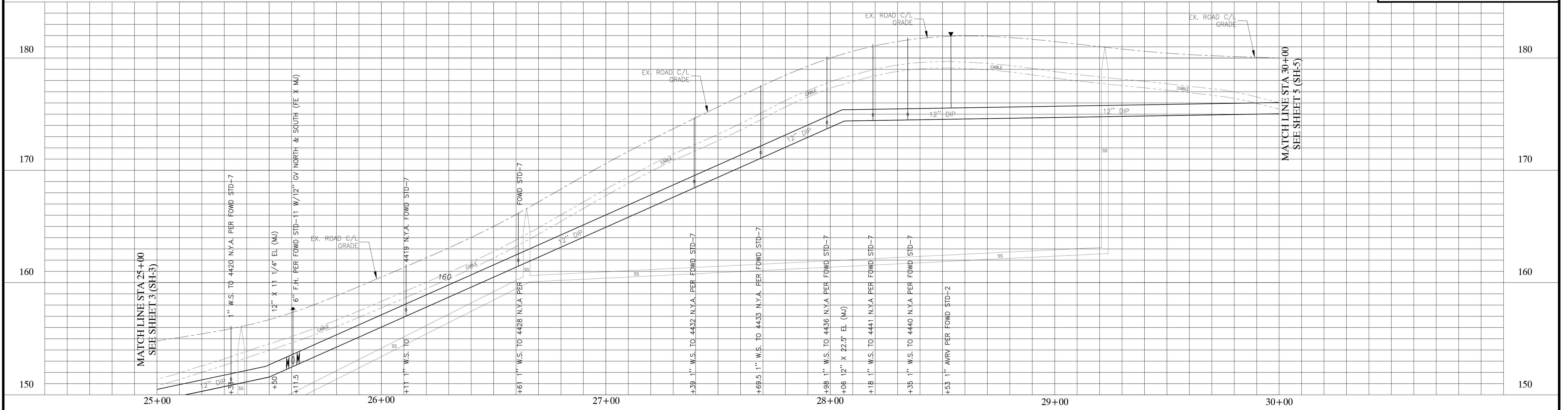

REVIEWED BY:	DATE:	DESIGNED BY:	REV.	DATE	DESCRIPTION	APP.
REVIEWED BY:	DATE:	DRAWN BY:				
REVIEWED BY:	DATE:	CHECKED BY:				
		DATE:				

FAIR OAKS WATER DISTRICT  
10326 FAIR OAKS BLVD. FAIR OAKS, CA 95628 (916) 967-5723  
**12" WATER MAIN REPLACEMENT PLAN ON NEW YORK AVENUE (PHASE I)**  
**PLAN-PROFILE**

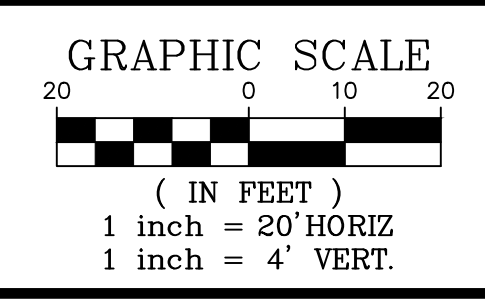

SHEET 4  
OF 7 SHEETS  
PROJECT NUMBER C24TDNYA

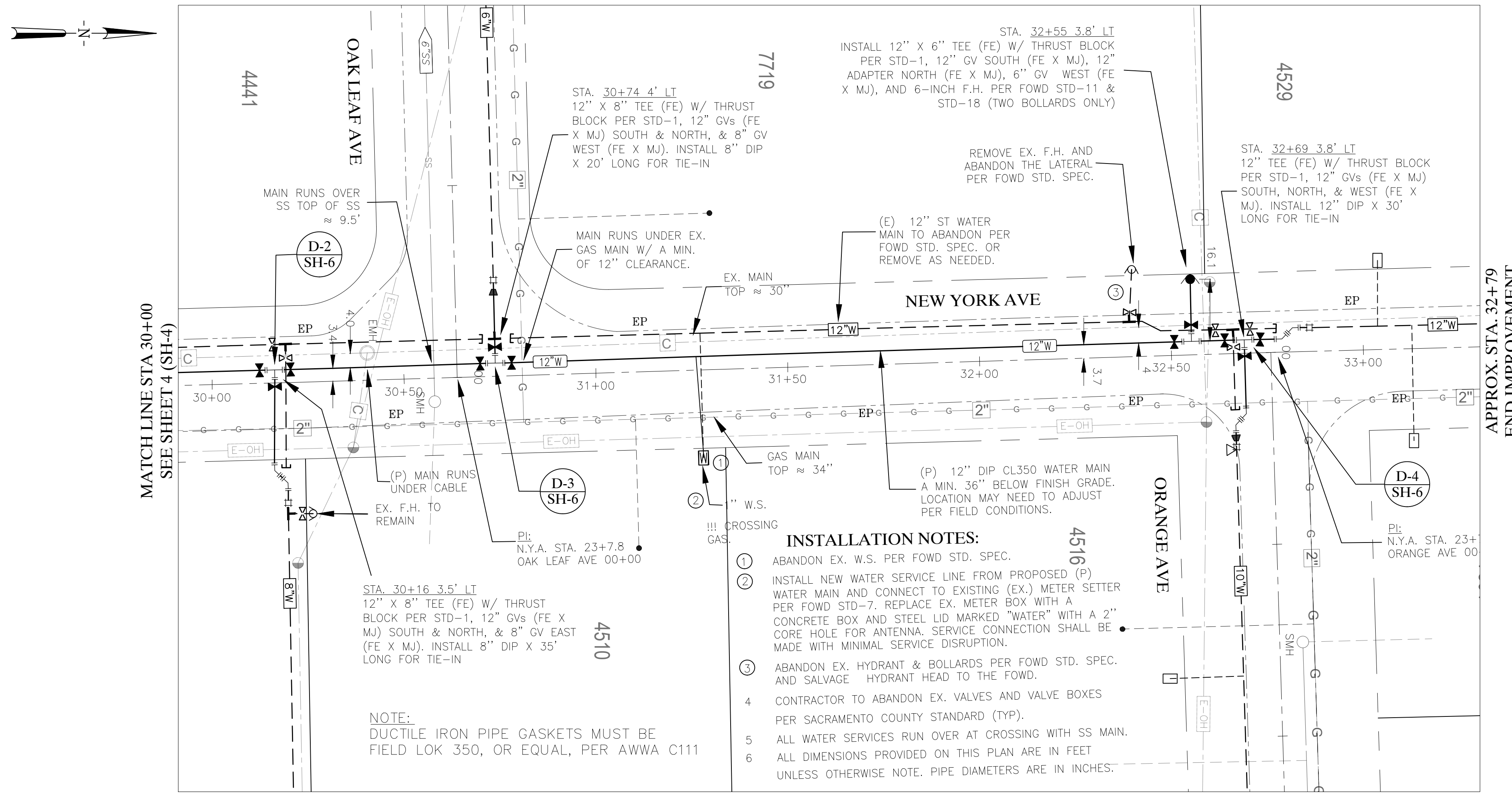

APPROX. STA. 32+79  
END IMPROVEMENT

NEW YORK AVE. - STA 30+00 TO STA. 32+79

**STORM DRAIN NOTE:**  
DRAINAGE INFORMATION AS SHOWN ON THIS PLAN ARE FROM SACRAMENTO COUNTY DEPARTMENT OF WATER RESOURCES, DRAINAGE FACILITY MAP #356/206 & 358/206.

PER SACRAMENTO COUNTY WATER RESOURCES: MAINTAIN 18" (INCHES) OF VERTICAL SEPARATION BETWEEN EX. STORM DRAIN AND (P) WATER MAIN AT ALL CROSSINGS (TYP). MECHANICAL INVERTS FOR WATER MAINS SHALL BE INSTALLED PER FOWD STD-17 WITH MIN. 18" OF VERTICAL SEPARATION.

**EXISTING FACILITIES NOTE:**  
THE TYPES, LOCATIONS, SIZES AND/OR DEPTHS OF EXISTING EX. UTILITIES WERE OBTAINED FROM OUTSIDE AGENCY AS-BUILTS AND MAY VARY IN RELIABILITY. THE CONTRACTOR SHALL POTHOLE AT ALL UTILITY CROSSINGS TO DETERMINE THE ACTUAL LOCATIONS, SIZE, TYPE, AND DEPTHS OF EX. UTILITIES. PRIOR TO COMMENCING CONSTRUCTION ACTIVITIES, CONTRACTOR SHALL NOTIFY FAIR OAKS WATER DISTRICT INSPECTOR TO DETERMINE ANY POSSIBLE CONFLICTS WITH INSTALLATION OF WATER MAIN AND APPURTENANCES. (TYP)

**SANITARY SEWER NOTE:**  
MAINTAIN 12" MINIMUM VERTICAL SEPARATION AT SANITARY SEWER CROSSINGS. PER CSD-1 A MINIMUM OF TEN (10') FEET OF HORIZONTAL (WALL-TO-WALL) CLEARANCE SHALL BE MAINTAINED BETWEEN PARALLEL SANITARY SEWER AND WATER DISTRIBUTION MAINS PER FOWD STANDARD SPEC. UNLESS OTHERWISE APPROVED. WATER CROSSINGS WITH SEWER MAINS LATERALS MUST BE DONE AS CLOSE TO PERPENDICULAR AS PRACTICABLE. CROSSING WITH AN ANGLE LESS THAN 45° SHALL NOT BE CONSTRUCTED.

**IMPORTANT NOTE:**  
PROPOSED (P) WATER FACILITIES CROSSING WITH EXISTING UTILITIES AT MULTIPLE LOCATIONS WITHIN THE PROJECT WHICH MAY REQUIRE (P) WATER FACILITIES TO BE INSTALLED DEEPER THAN REGULAR DEPTH OF 36" FROM FINISH GRADE. CONTRACTOR TO POTHOLE (AT CONTRACTOR EXPENSE) EVERY CROSSING PRIOR TO START OF TRENCHING.

**EROSION/SEDIMENT CONTROL NOTE:**  
PER SAC COUNTY WATER RESOURCES; SEE SHEET 6 ATTACHED WITH THESE PLANS FOR EROSION/SEDIMENT CONTROL MEASURES WITHIN PROJECT LIMITS.

**FINAL PLAN**  
**PIPELINE IMPROVEMENTS**

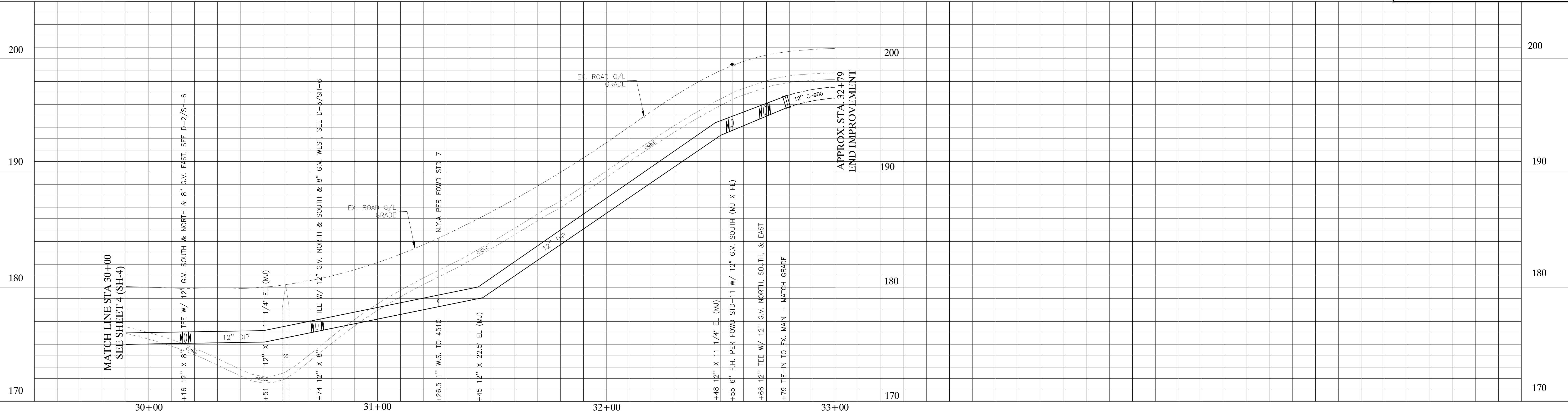

REVIEWED BY:	DATE:	DESIGNED BY:	REV.	DATE	DESCRIPTION	APP.
REVIEWED BY:	DATE:	DRAWN BY:				
REVIEWED BY:	DATE:	CHECKED BY:				
		DATE:				

FAIR OAKS WATER DISTRICT  
10326 FAIR OAKS BLVD. FAIR OAKS, CA 95628 (916) 967-5723  
**12" WATER MAIN REPLACEMENT PLAN ON NEW YORK AVENUE (PHASE I)**  
**PLAN-PROFILE**

GRAPHIC SCALE  
1 inch = 20' HORIZ  
1 inch = 4' VERT.

FAIR OAKS WATER DISTRICT

SHEET 5  
OF 7 SHEETS  
PROJECT NUMBER C24TDNYA

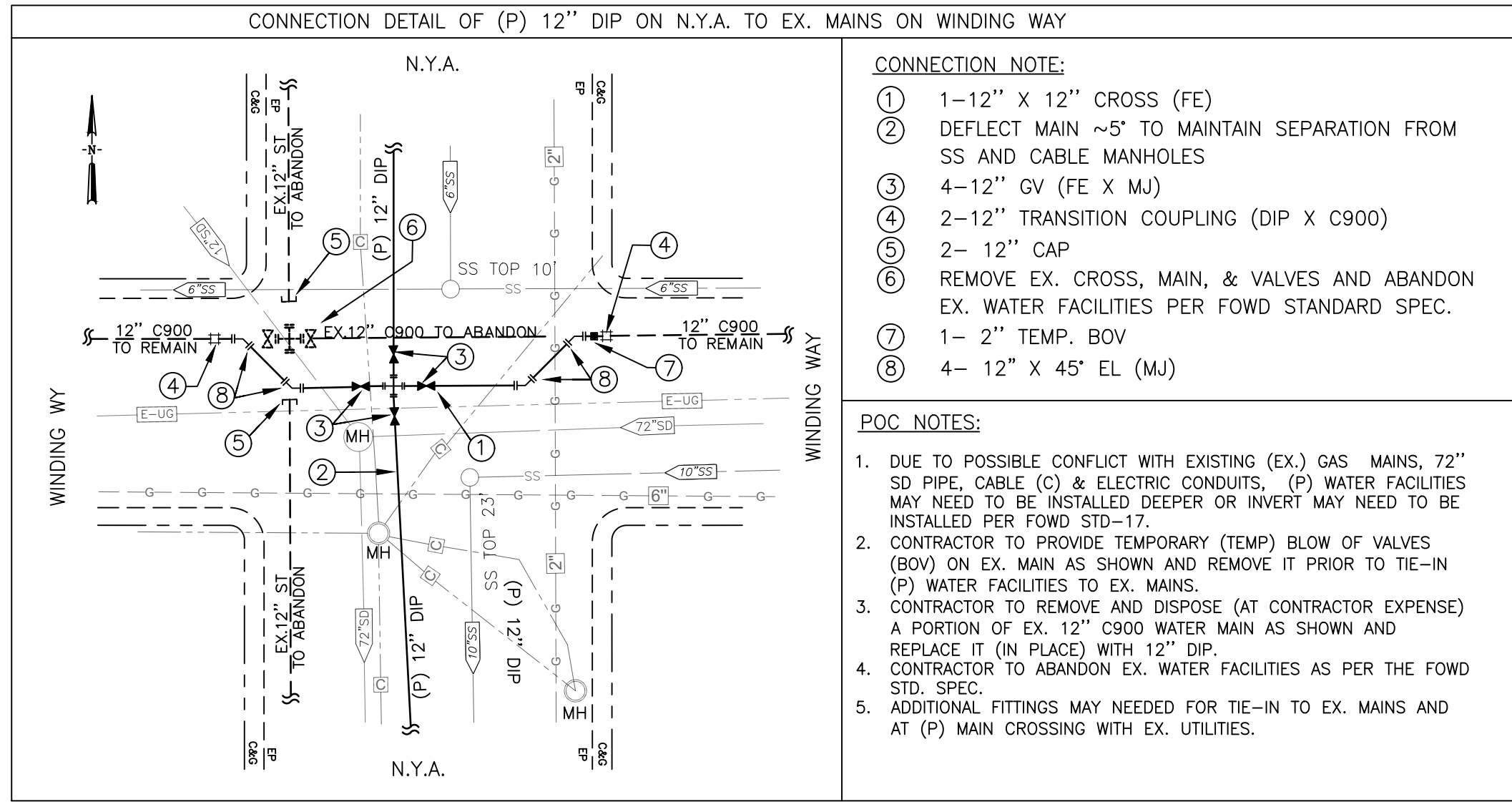

D-1 STA. 23+15  
NTS

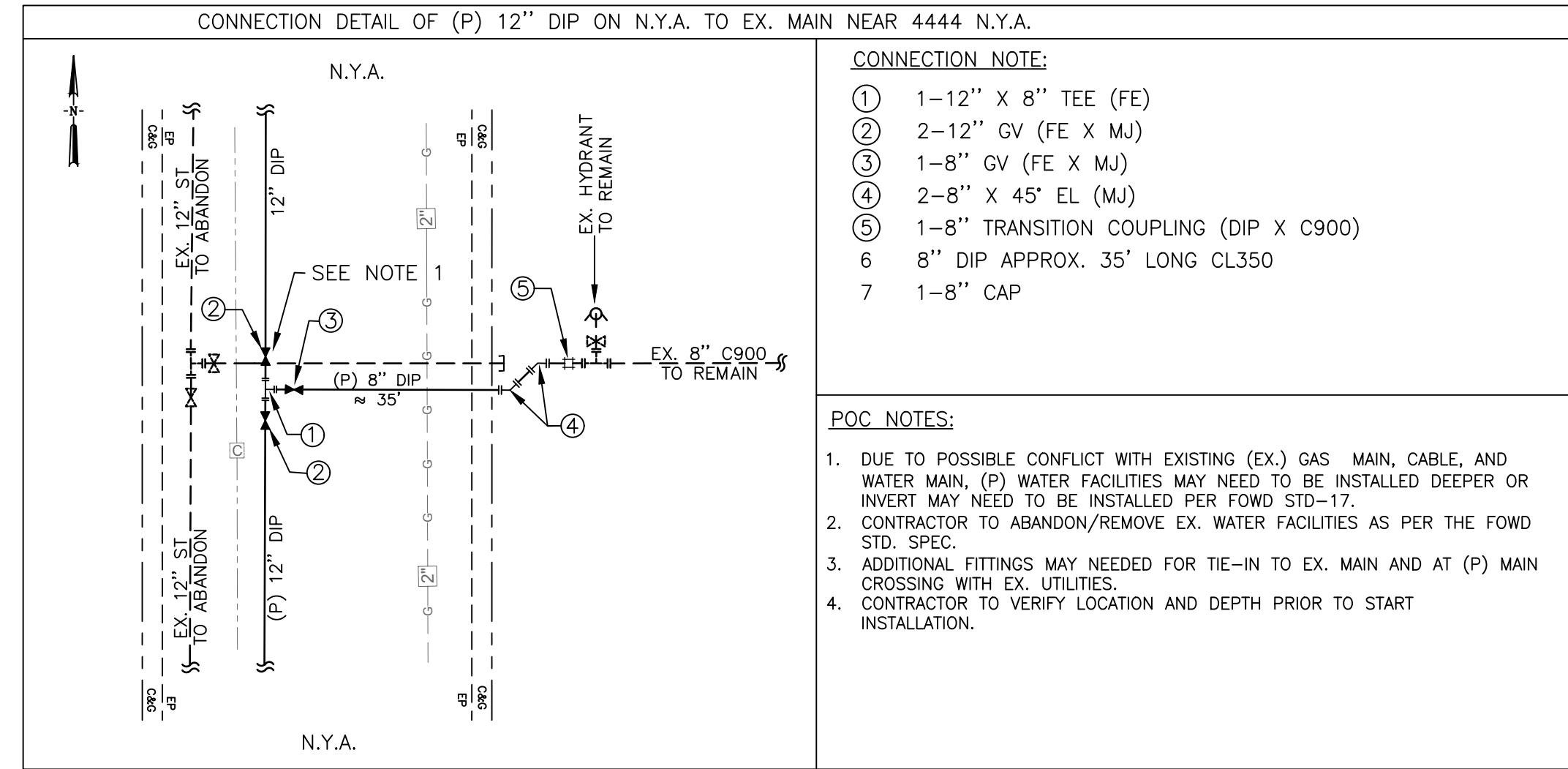

D-2 STA. 30+16  
NTS

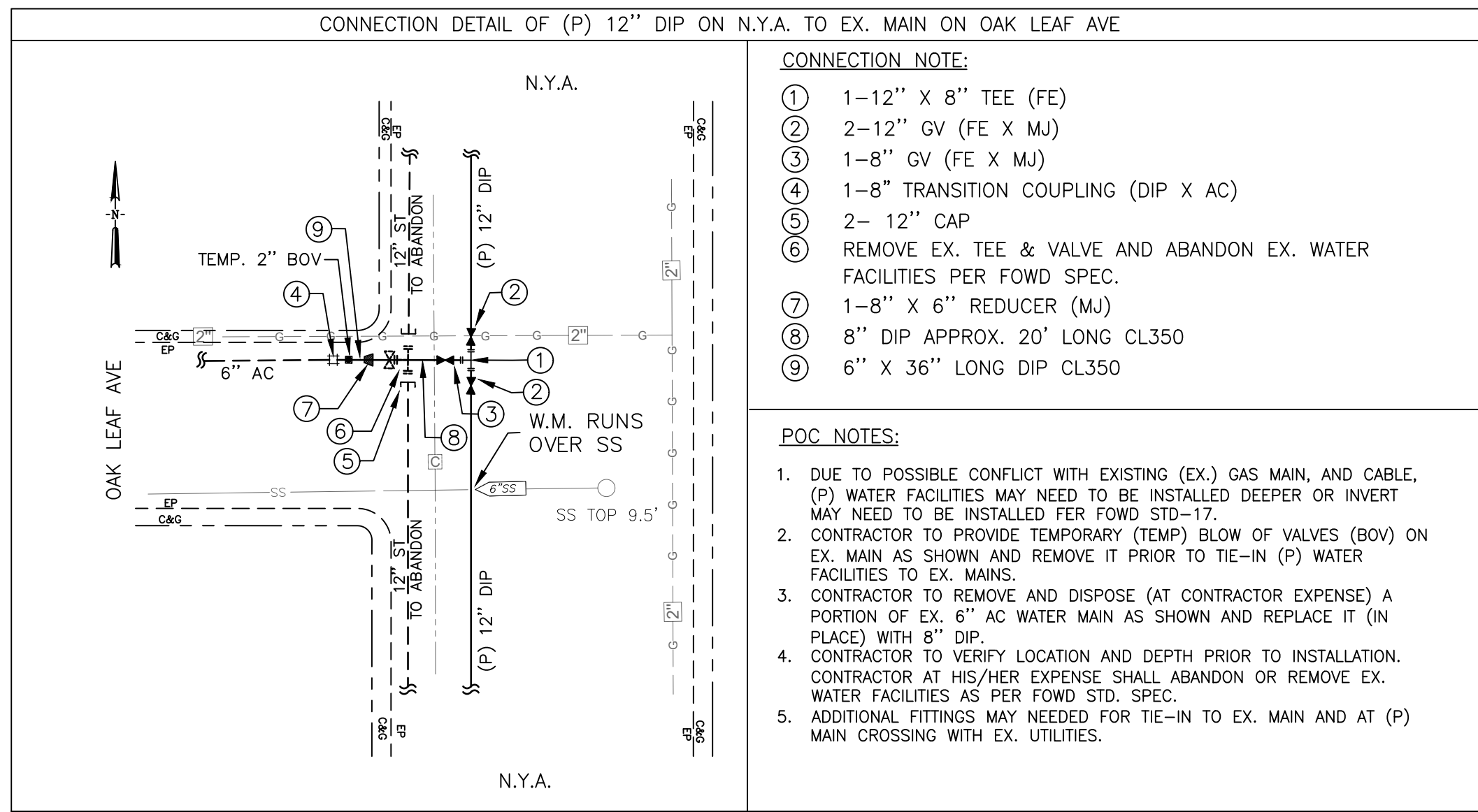

D-3 STA. 30+74  
NTS

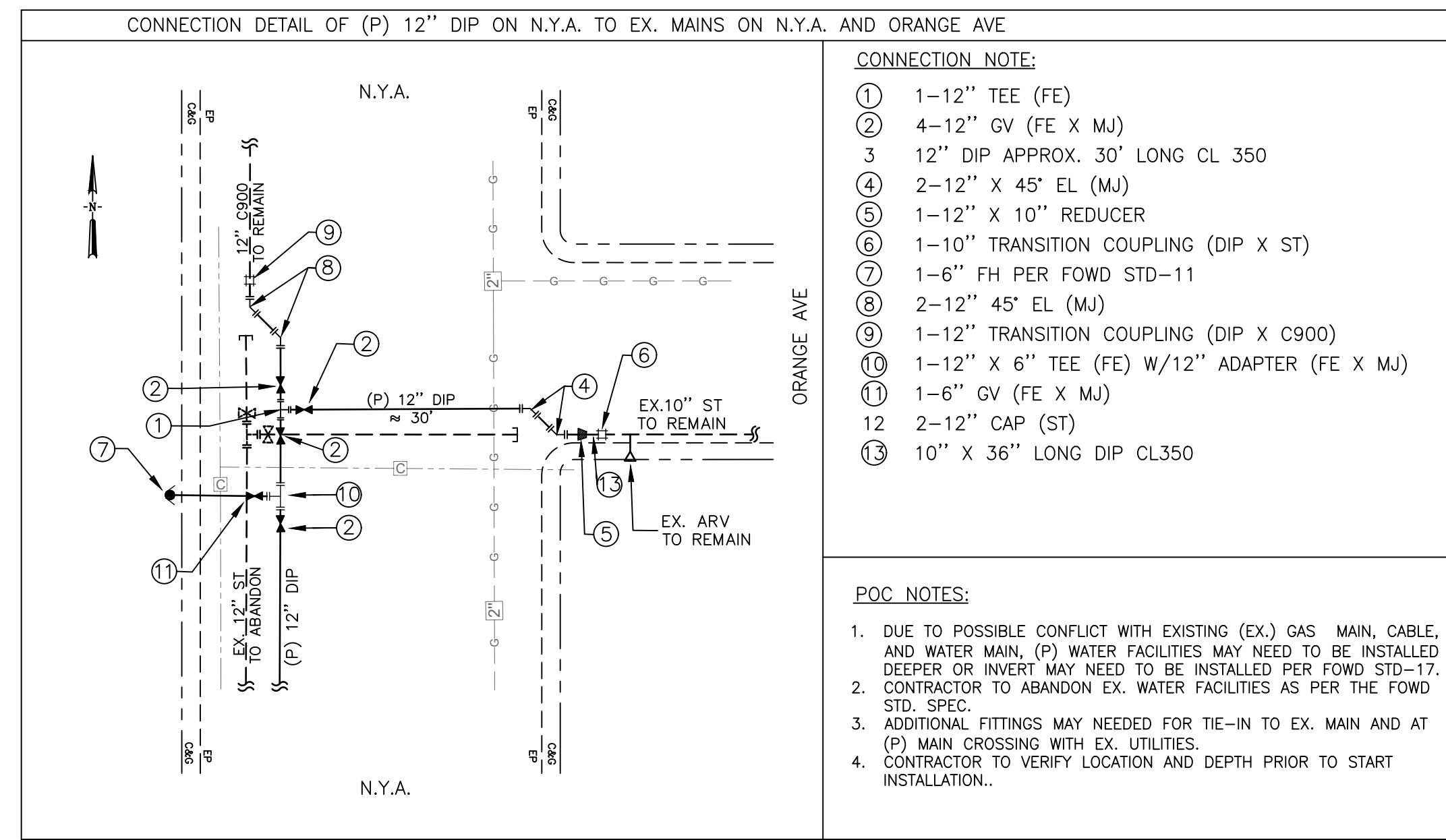

D-4 STA. 32+69  
NTS

INSTALL NEW SERVICE LINE TO EXISTING METERED SERVICES

NO.	EXISTING ADDRESSES	EXISTING SERVICE LINE	EXISTING SIZE AND METER	EXIST FOWD ACCOUNT #
1	4266 New York Ave	VERIFY	1.5" METER	4844
2	4267 New York Ave (New York Well Site)	NEW	2" METER	To Be Created
3	4300 New York Ave	VERIFY	1" METER	4845
4	4304 New York Ave	VERIFY	1" METER	4846
5	4305 New York Ave	VERIFY	1" METER	4881
6	4307 New York Ave	VERIFY	2" METER	4880
7	4310 New York Ave	VERIFY	1" METER	4829
8	4324 New York Ave	VERIFY	1.5" METER	4830
9	4333 New York Ave	VERIFY	1.5" METER	4879
10	4336 New York Ave	VERIFY	1" METER	4828
11	4341 New York Ave	VERIFY	1" METER	4878
12	7804 Winding Way	VERIFY	1" METER	4827
13	4400 New York Ave	VERIFY	1" METER	6021
14	4401 New York Ave	VERIFY	1" METER	5453
15	4411 New York Ave	VERIFY	1" METER	5454
16	4419 New York Ave	VERIFY	1" METER	5455
17	4420 New York Ave	VERIFY	1" METER	6020
18	4428 New York Ave	VERIFY	1" METER	6030
19	4432 New York Ave	VERIFY	1" METER	6029
20	4433 New York Ave	VERIFY	1" METER	5456
21	4436 New York Ave	VERIFY	1" METER	6028
22	4440 New York Ave	VERIFY	1" METER	5988
23	4441 New York Ave	VERIFY	1" METER	5458
24	4510 New York Ave	VERIFY	1" METER	5985

SEWER NOTE:

A MINIMUM OF TEN (10') FEET OF HORIZONTAL (WALL-TO-WALL) CLEARANCE SHALL BE MAINTAINED BETWEEN PARALLEL SANITARY SEWER AND WATER DISTRIBUTION MAINS (PER FOWD STANDARD SPECIFICATIONS MANUAL SECTION 4.2.1) OR AS APPROVED BY THE FOWD.

MAINTAIN A MINIMUM OF 12-INCHES VERTICAL SEPARATION AT SANITARY SEWER CROSSING WITH PROPOSED WATER MAINS.

WATER CROSSINGS WITH SEWER MAINS LATERALS MUST BE DONE AS CLOSE TO PERPENDICULAR AS PRACTICABLE (PER FOWD STANDARD SPECIFICATIONS MANUAL SECTION 4.2).

EXISTING FACILITIES NOTE:

THE TYPES, LOCATIONS, SIZES AND/OR DEPTHS OF EXISTING EX. UTILITIES WERE OBTAINED FROM OUTSIDE AGENCY AS-BUILTS AND MAY VARY IN RELIABILITY. THE CONTRACTOR SHALL POPTHOLE AT ALL UTILITY CROSSINGS TO DETERMINE THE ACTUAL LOCATIONS, SIZE, TYPE, AND DEPTHS OF EX. UTILITIES. PRIOR TO COMMENCING CONSTRUCTION ACTIVITIES. CONTRACTOR SHALL NOTIFY FAIR OAKS WATER DISTRICT INSPECTOR TO DETERMINE ANY POSSIBLE CONFLICTS WITH INSTALLATION OF WATER MAIN AND APPURTENANCES. (TYP)

CONSTRUCTION NOTE:

MAINTAIN MINIMUM 18" (INCHES) VERTICAL SEPARATION BETWEEN WATER MAIN AND EXISTING STORM DRAINS, ALL OTHER UTILITIES MAINTAIN MINIMUM 12" VERTICAL SEPARATION.

LANDSCAPE AREAS DISTURBED DURING CONSTRUCTION ACTIVITIES SHALL BE RESTORED TO PRE-CONSTRUCTION CONDITIONS.

FAIR OAKS WATER DISTRICT (FOWD) OFFICE CAN BE REACHED AT (916) 967 5723.

MECHANICAL INVERT NOTE:

MECHANICAL INVERTS FOR WATER MAINS SHALL BE INSTALLED PER FOWD STD-17 WITH 12" OF VERTICAL SEPARATION WHERE CONFLICTS OCCUR. NOT JOINTS IN WATER MAIN SHALL BE PROVIDED AT CROSSING AND WITHIN 8' ON BOTH SIDE.

WATER FACILITIES INSTALLATION NOTES:

- INSTALLATION DETAIL DEFERENT THAN LISTED, SHALL BE RECORDED ON THE PLAN.
- CONNECTION BETWEEN FITTING AND PIPE SHALL BE MECHANICAL JOINT (TYP).
- TEMPORARY BLOW-OFF VALVE INSTALLATION SHALL BE DETERMINED BY THE FOWD CONSTRUCTION INSPECTOR IN THE FIELD.

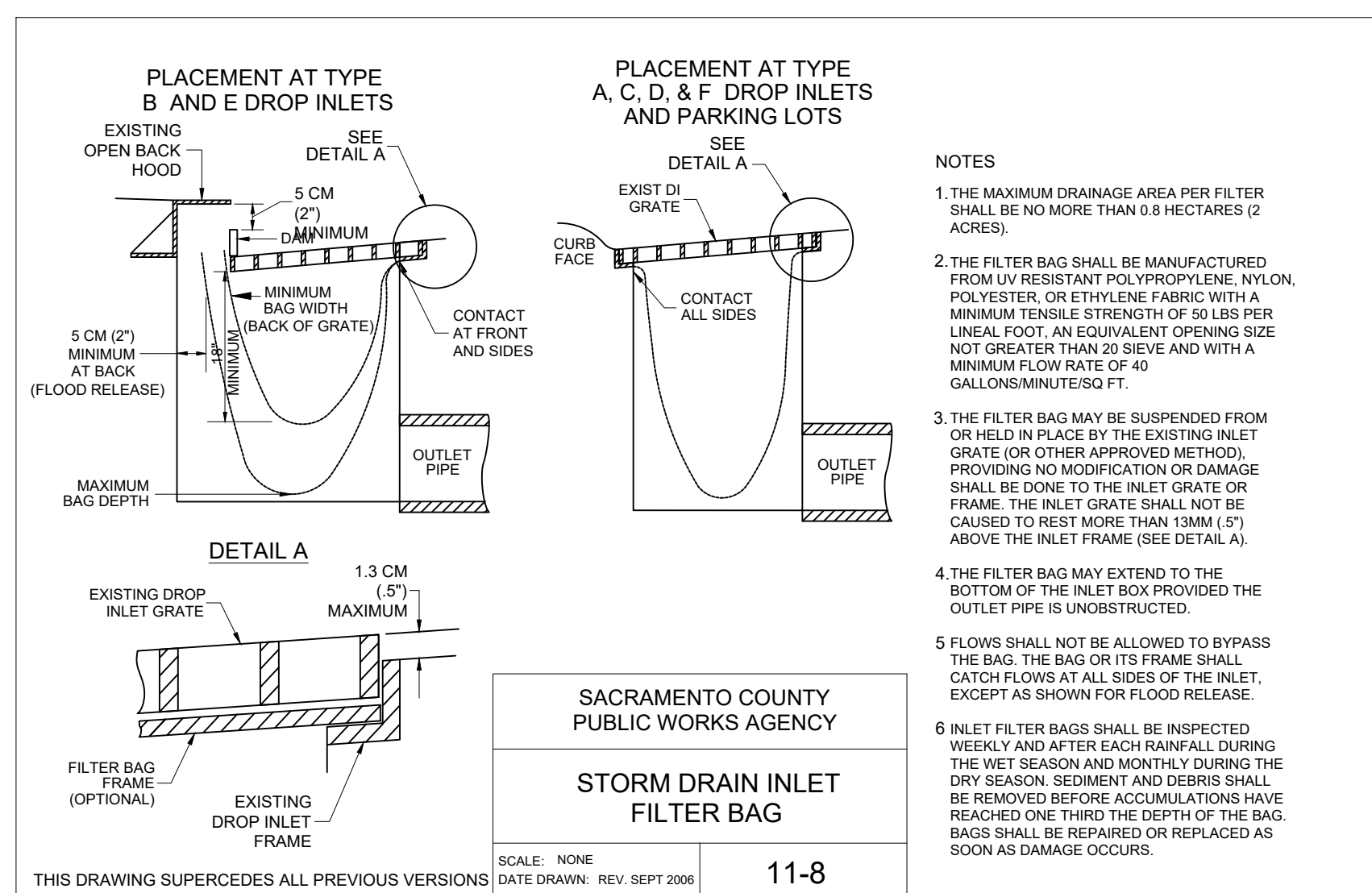

SACRAMENTO COUNTY PUBLIC WORKS AGENCY  
STORM DRAIN INLET FILTER BAG  
SCALE: NONE  
DATE DRAWN: REV. SEPT 2006  
11-8

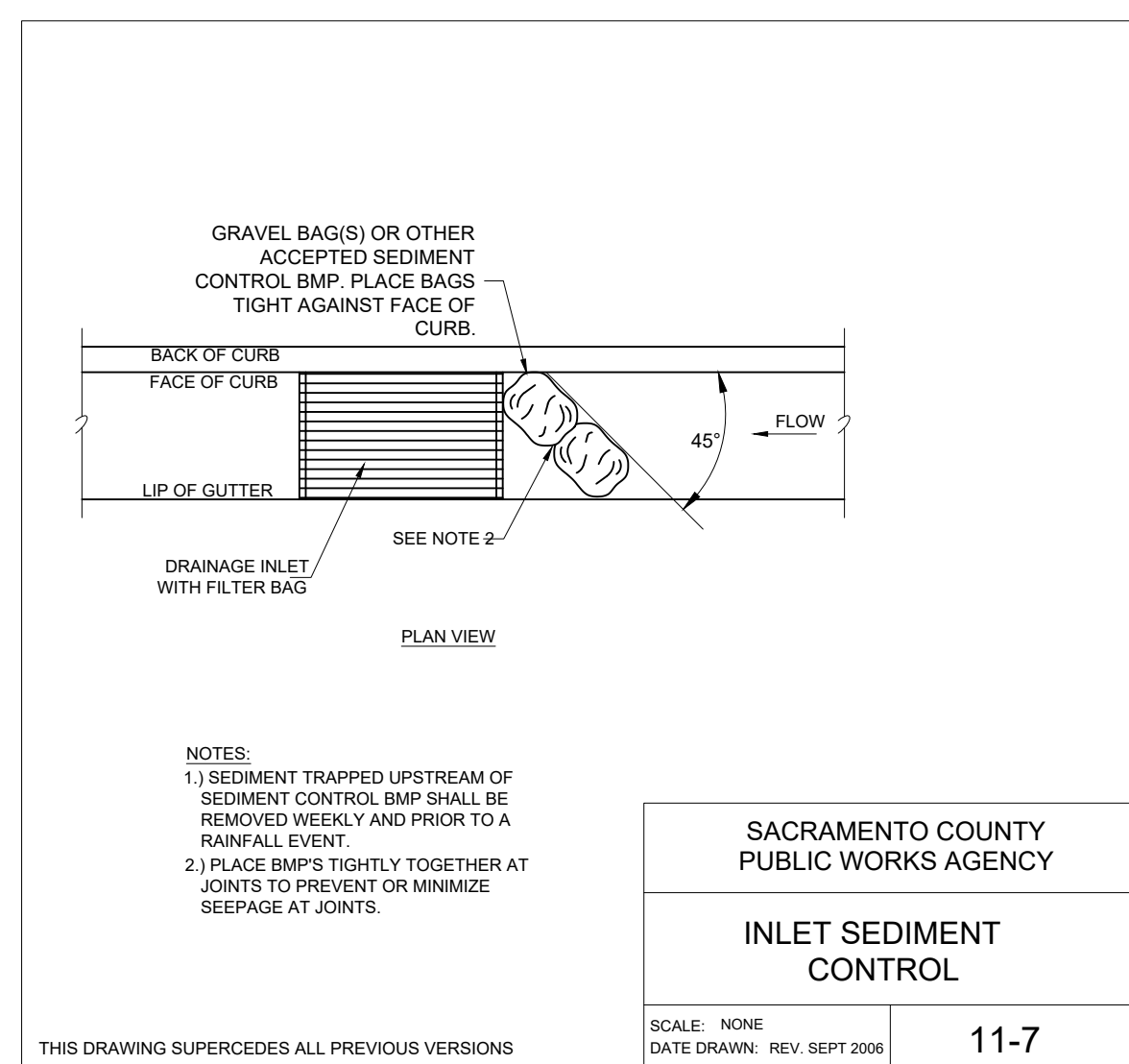

SACRAMENTO COUNTY PUBLIC WORKS AGENCY  
INLET SEDIMENT CONTROL  
SCALE: NONE  
DATE DRAWN: REV. SEPT 2006  
11-7

EROSION CONTROL

SEDIMENT BMP

COUNTY NOTE:

SEE COUNTY DRAINAGE FACILITY MAP 356/206 & 358/206 FOR LOCATIONS

EROSION/SEDIMENT CONTROL

PER SACRAMENTO COUNTY WATER RESOURCES: EROSION/SEDIMENT CONTROL MEASURES SHALL BE INSTALLED IN DRAIN INLETS WITHIN THE PROJECT AREA PRIOR TO BEGINNING OF CONSTRUCTION ACTIVITIES.

EROSION/SEDIMENT CONTROL MEASURES ARE TO BE MAINTAINED THROUGHOUT CONSTRUCTION ACTIVITY AND DURING PERIODS OF RAIN.  
SEE ABOVE FOR PLACEMENT AND LOCATIONS. COUNTY DRAINAGE FACILITY MAP 356/206 & 358/206

REVIEWED BY:	DATE:	DESIGNED BY:	A. SHAFQAQ				
REVIEWED BY:	DATE:	DRAWN BY:	A. SHAFQAQ				
REVIEWED BY:	DATE:	CHECKED BY:	P. SIEBENSCHON				
		DATE:	5/7/2024	REV.	DATE	DESCRIPTION	APP.

FAIR OAKS WATER DISTRICT  
10326 FAIR OAKS BLVD, FAIR OAKS, CA 95628, (916) 967-5723

12" WATER MAIN REPLACEMENT PLAN ON NEW YORK AVENUE (PHASE I)  
POINT OF CONNECTIONS and EROSION & SEDIMENT CONTROL DETAILS

DATE: \_\_\_\_\_ DATE: \_\_\_\_\_

SCALE: \_\_\_\_\_

HORIZ: N/A

VERT: N/A

VER.: \_\_\_\_\_

SHEET 6  
OF 7 SHEETS  
PROJECT NUMBER C24TDNYA

**HORIZONTAL THRUST (LBS)  
MINIMUM BEARING AREA (SQUARE FEET)**

FITTING SIZE	22 1/2" BEND		45" BEND		90" BEND		TEE OR DEAD END	
	THRUST	AREA	THRUST	AREA	THRUST	AREA	THRUST	AREA
4"	1,450	2	2,800	4	5,700	8	7,600	4
6"	2,900	3	5,800	5	11,700	10	15,200	7
8"	5,100	5	10,100	8	19,900	16	21,900	12
10"	8,300	8	16,600	12	33,300	24	35,300	18
12"	11,900	12	23,800	18	47,600	36	50,600	27
14"	16,100	18	32,200	24	64,400	48	68,400	36
16"	20,900	24	41,800	32	83,600	64	88,600	48
24"	—	—	—	—	—	—	—	—

**TYPICAL DIMENSIONS**

BEARING AREA SQUARE FEET	HORIZ. FEET	VERT. FEET	MIN. DISTANCE FEET
2	2	1.5	1
3	3	2	1.5
4	4	2.5	2
5	5	3	2.5
6	6	3.5	3
7	7	4	3.5
8	8	4.5	4
9	9	5	4.5
10	10	5.5	5
12	12	6.5	6
14	14	7.5	7
16	16	8.5	8
18	18	9.5	9
20	20	10.5	10
24	24	12.5	12
27	27	14.5	14
30	30	16.5	16
36	36	19.5	19
48	48	25.5	25
60	60	31.5	31

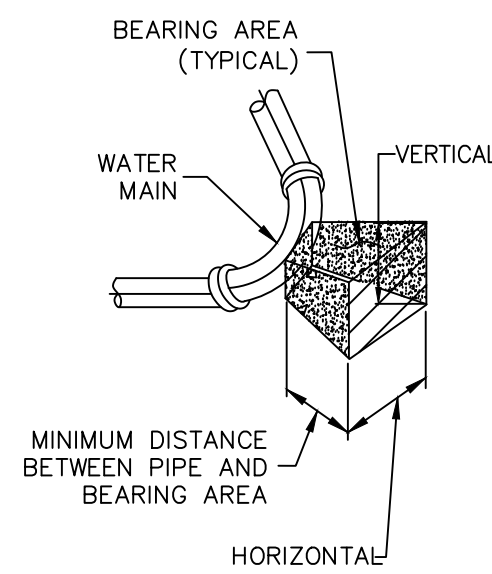

- NOTES:**
- THRUST BLOCKS TO BE POURED AGAINST UNDISTURBED SOIL.
  - MINIMUM VOLUME OF THRUST BLOCK IS 3 CUBIC FEET.
  - THE ABOVE TABLES ARE BASED ON A SOIL HAVING A BEARING VALUE OF 2000 PSF. FOR OTHER SOILS MULTIPLY THE BEARING AREA BY THE FOLLOWING FACTORS.

MUCK	0 PSF	NOT ACCEPTABLE
SOFT CLAY	1000 PSF	MULTIPLY BEARING AREA BY 2.0
SAND	2000 PSF	NO ADJUSTMENT
SAND AND GRAVEL	3000 PSF	MULTIPLY BEARING AREA BY 0.66
SAND AND GRAVEL CEMENTED WITH CLAY	4000 PSF	MULTIPLY BEARING AREA BY 0.5

- THE ABOVE TABLES ARE BASED ON A TEST PRESSURE OF 200 PSI FOR OTHER PRESSURES ADJUST PROPORTIONATELY.

**THRUST BLOCK DETAILS**  
Standard Drawing 1

**NOTES:**

- MAINTAIN 2% POSITIVE SLOPE TO AIR RELEASE VALVE.
- FOR INSTALLATION IN AREAS WITH SIDEWALKS, PLACE AIR RELEASE VALVE BEHIND SIDEWALK.
- PLACE AWG 10 TRACER WIRE TAPED TO COPPER LINE.

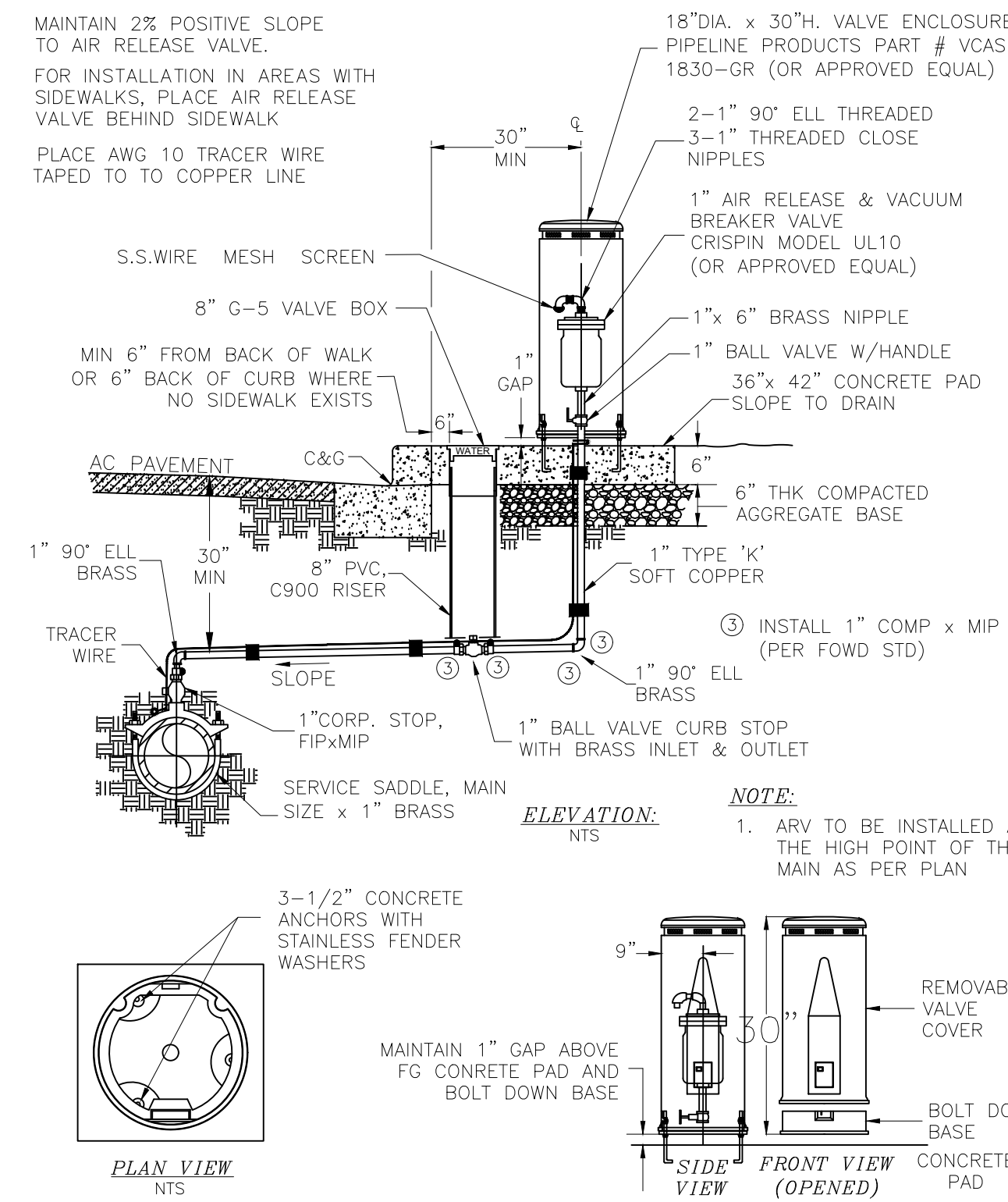

**1" AUTOMATIC AIR & VACUUM  
RELEASE VALVE**  
Standard Drawing 2-1

**NOTES:**

- WIRE TO BE CONTINUOUS BETWEEN VALVE BOXES.
- LOCATING WIRE TO BE LAID LOOSELY OVER TOP OF PIPE AND TAPED EVERY 5' (MINIMUM).
- A CONTINUITY TEST SHALL BE PERFORMED BY CONTRACTOR AT TIME OF FINAL ACCEPTANCE AND WITNESSED BY FOWD AUTHORIZED REPRESENTATIVE.

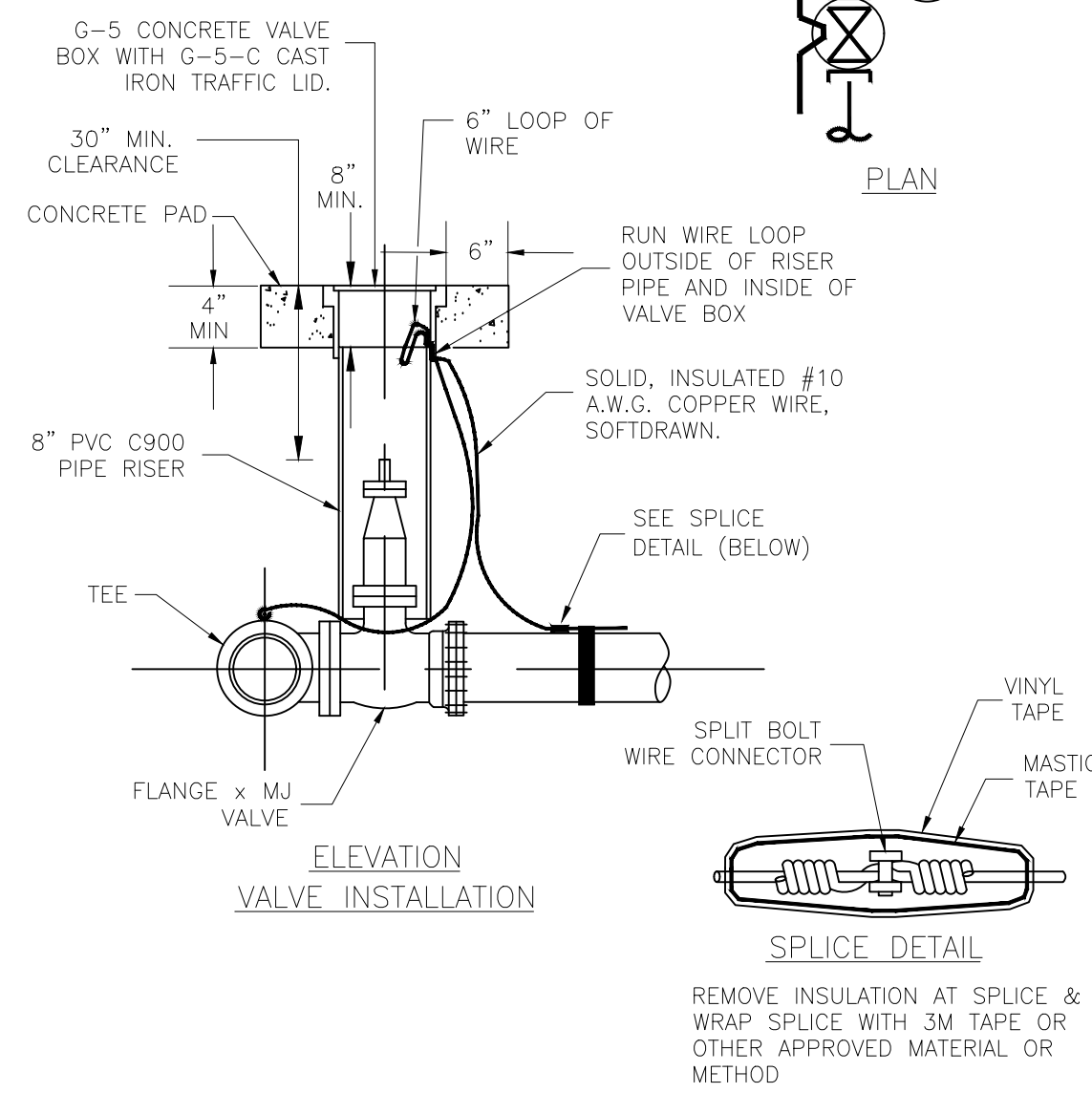

**VALVE AND LOCATING WIRE  
INSTALLATION**  
Standard Drawing 5

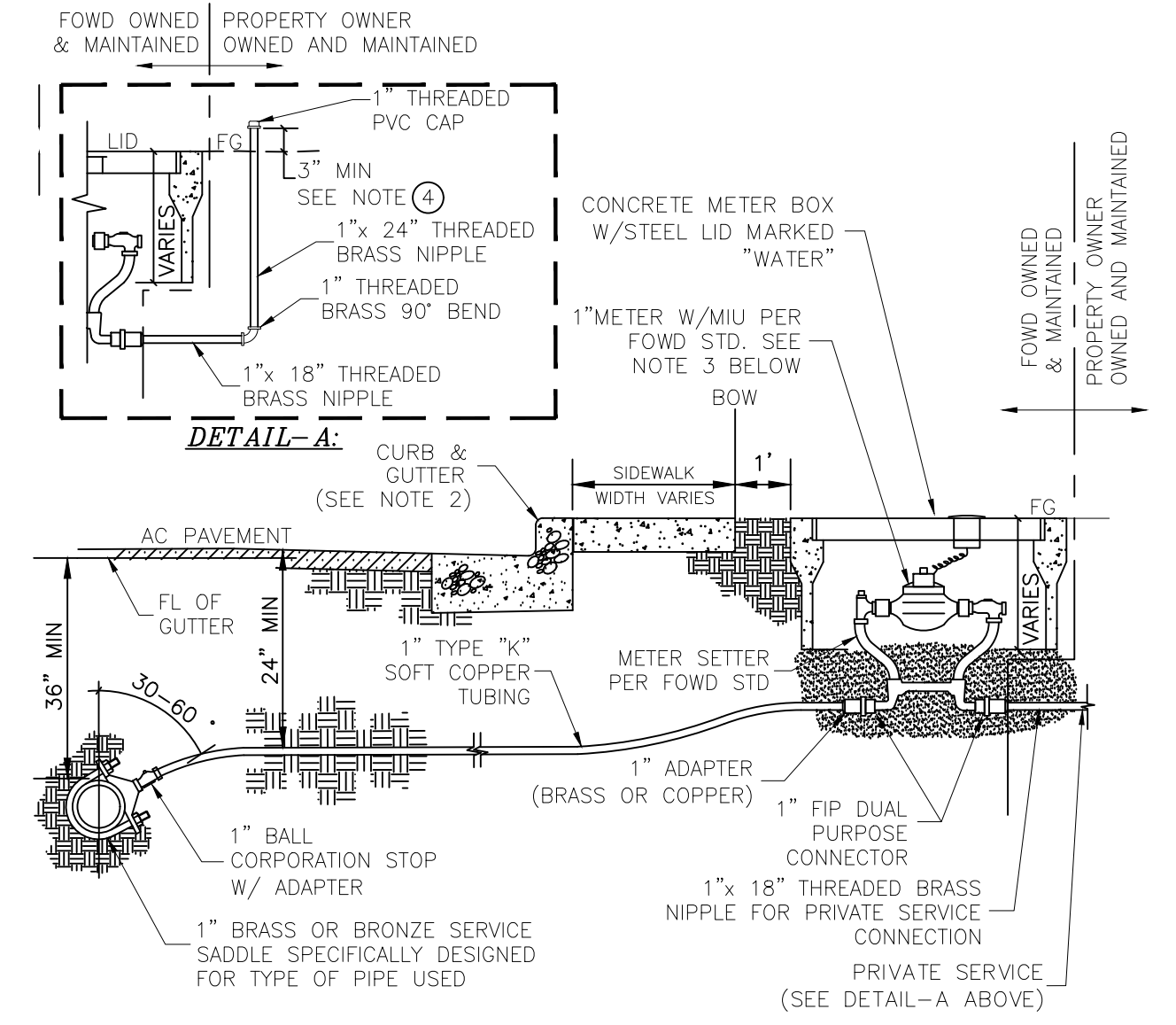

- NOTES:**
- LARGER 1-1/2" AND 2" SERVICES ARE CONSTRUCTED IN A MANNER SIMILAR TO 1" SERVICE. REFER TO FOWD STANDARD SPECIFICATIONS.
  - CONTRACTOR SHALL IMPRINT OR STENCIL CURB FACE WITH A "W" TO INDICATE LOCATION OF SERVICE LINE.
  - METER SHALL BE A NEPTUNE T-10 ENHANCED WITH NEPTUNE PRO-CODER@9001 RADIO FREQUENCY METER INTERFACE UNIT (MIU) OR APPROVED EQUAL BY THE FOWD.
  - 24" BRASS RISER (3" MIN ABOVE FINISH GRADE) PROVIDED FOR CUSTOMER TO MAKE CONNECTION WITH APPROVED BACKFLOW DEVICE (SEE STD-21)

**1" WATER METER  
INSTALLATION**  
Standard Drawing 7

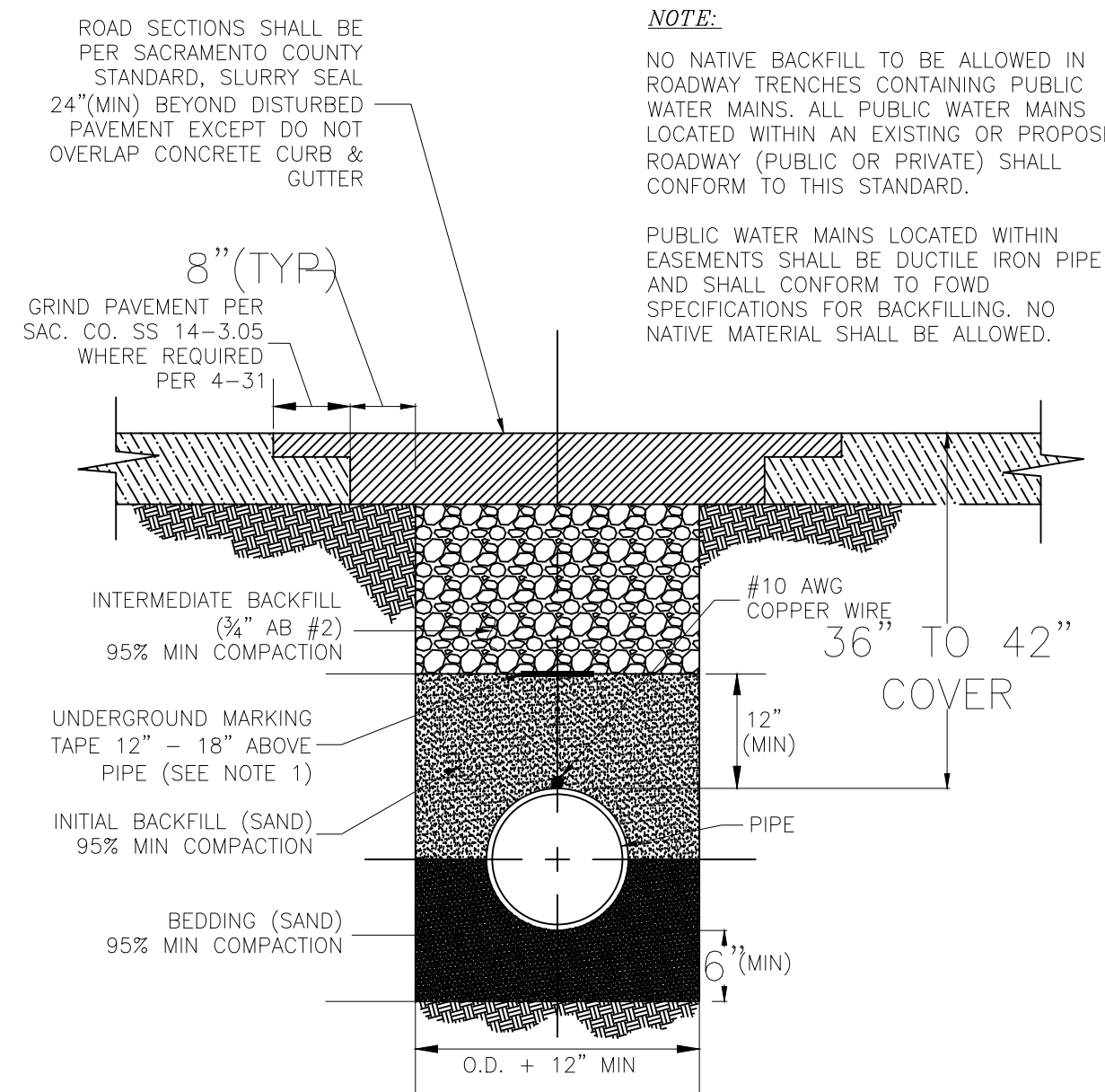

**TRENCH CROSS SECTION FOR  
PIPE BEDDING AND BACKFILL**  
Standard Drawing 9

- NOTE:**
- NO NATIVE BACKFILL TO BE ALLOWED IN ROADWAY TRENCHES CONTAINING PUBLIC WATER MAINS. ALL PUBLIC WATER MAINS LOCATED WITHIN AN EXISTING OR PROPOSED ROADWAY (PUBLIC OR PRIVATE) SHALL CONFORM TO THIS STANDARD.
  - PUBLIC WATER MAINS LOCATED WITHIN EASEMENTS SHALL BE DUCTILE IRON PIPE AND SHALL CONFORM TO FOWD SPECIFICATIONS FOR BACKFILLING. NO NATIVE MATERIAL SHALL BE ALLOWED.

- NOTE 1:**
- WARNING TAPE SHALL BE INSTALLED ABOVE ALL WATER MAINS. TAPE SHALL BE 12" WIDE AND BE APPROVED FOR EXTENDED UNDERGROUND USE. TAPE SHALL BE BLUE AND BE MARKED "WATER MAIN BURIED BELOW" IN BLACK LETTERING.

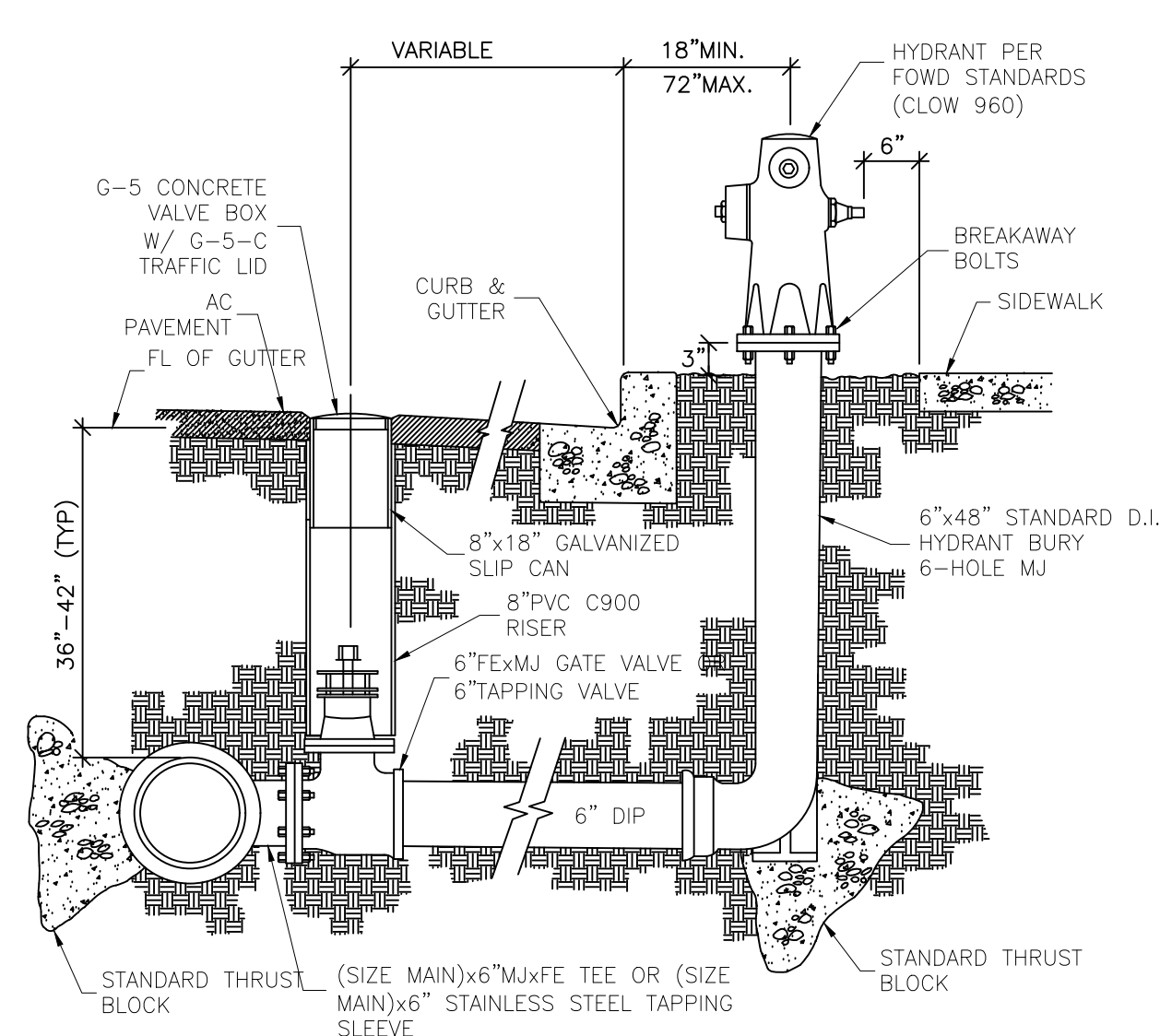

**6" WET BARREL  
FIRE HYDRANT**  
Standard Drawing 11

- NOTES:**
- ON ROADS WITHOUT CURBS, FIRE HYDRANTS SHALL BE LOCATED WITHIN THE ROAD RIGHT OF WAY, ONE FOOT CLEAR FROM THE PROPERTY LINE UNLESS OTHERWISE INDICATED ON THE PLANS.
  - HYDRANT & RISER ARE TO BE PAINTED PER LOCAL FIRE DEPARTMENT REQUIREMENTS, CONTRACTOR TO SUPPLY PAINT AND PRIMER.
  - IF GATE CAN INSTALLED IN CONCRETE, USE FOWD APPROVED G-5 VALVE BOX OR EQUIVALENT.

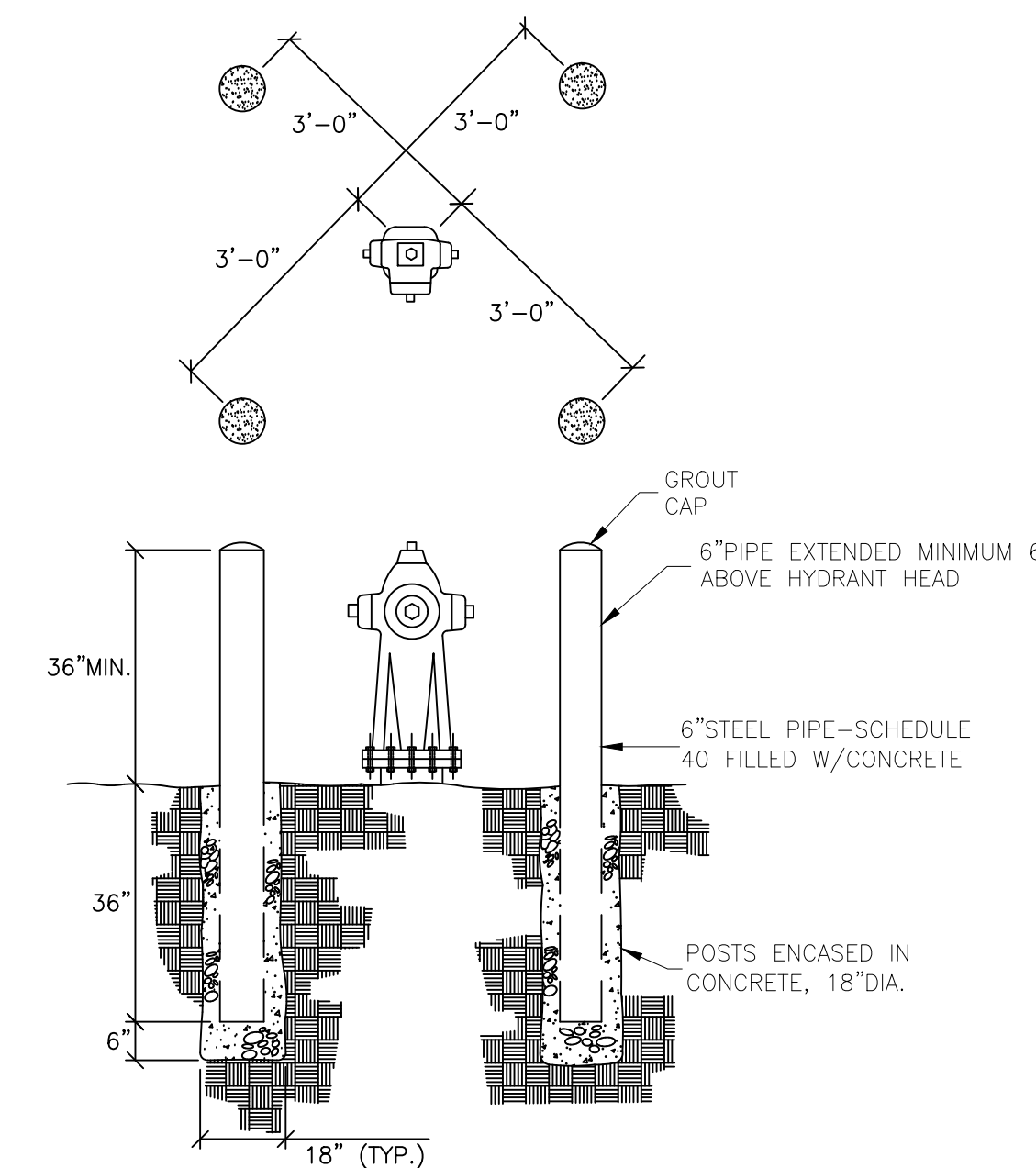

**FIRE HYDRANT BOLLARDS**  
Standard Drawing 19

- NOTES:**
- ORIENTATION OF BARRICADE MAY BE CHANGED ACCORDING TO FIELD CONDITIONS.
  - BARRICADE AND HYDRANT ARE TO BE PAINTED PER LOCAL FIRE DEPARTMENT REQUIREMENTS, CONTRACTOR TO SUPPLY PAINT AND PRIMER.
  - COATING SHALL BE PER COMPANY PAINTING SPECIFICATIONS FOR ABOVE GRADE STEEL PIPING.

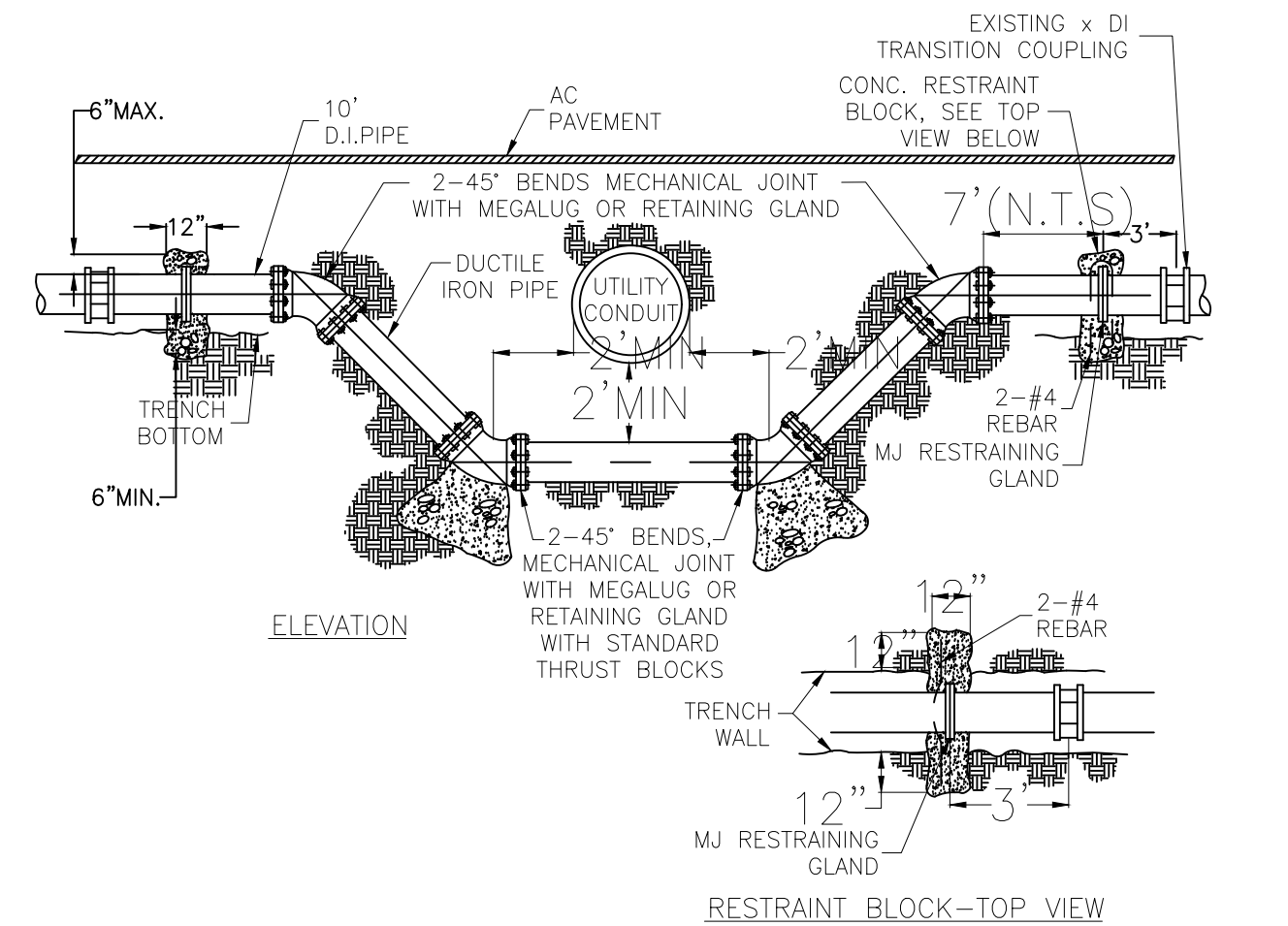

**45° MECHANICAL JOINT  
UTILITY INVERT**  
Standard Drawing 17

- NOTES:**
- THE RESTRAINT BLOCKS SHALL BE A MINIMUM OF 24" IN HEIGHT AND 12" THICK. THE TOP OF THE BLOCK SHALL BE NO MORE THAN 6" ABOVE THE TOP OF PIPE.
  - ALL PIPE JOINTS AT 45° BENDS SHALL BE MECHANICAL JOINT WITH MEGALUG OR RETAINING GLAND, FLANGED JOINTS MAY BE USED WHERE CONDITIONS WARRANT.
  - INSTALLATION SHALL BE ENCASED IN A POLYETHYLENE WRAPPER PER AWWA STANDARD C105.
  - IF BOTTOM CHORD EXCEEDS 18', CONNECT PIPE SECTIONS WITH FIELD LOCK GASKETS.

REVIEWED BY:	DATE:	DESIGNED BY:	REV.	DATE	DESCRIPTION	APP.
		A.SHAFAQ				
		A.SHAFAQ				
		P.SIEBENSCHN				
		5/7/2024				

**FAIR OAKS WATER DISTRICT**  
10326 FAIR OAKS BLVD, FAIR OAKS, CA 95628, (916) 967-5723  
**12" WATER MAIN REPLACEMENT PLAN ON NEW YORK AVENUE (PHASE I)**  
**FOWD STANDARD DRAWINGS**

DATE: \_\_\_\_\_  
SCALE: N/A  
HORIZ: N/A  
VERT: N/A  
VER.: \_\_\_\_\_



SHEET 7  
OF 7 SHEETS  
PROJECT NUMBER  
C24TDNYA

**May 20, 2024**

**Staff Report Briefing Materials**

**AGENDA ITEM VI.1**

**Discussion on FOWD Water Supply for the month of April 2024**

**AGENDA ITEM VI.1**  
REGULAR Board Meeting May 20, 2024

To: Board of Directors  
 From: Paul Siebensohn  
 Date: May 8, 2024  
 Subject: Discussion on FOWD Water Supply for the month of April 2024

**Recommendation:**

None.

**Discussion:**

According to the Accuweather.com website, the recorded average daily temperature in April 2024 was 58.5° F, which is 2.5 degrees below the historic average of 61.0° F for April. Precipitation for April 2024 was recorded at 1.49” according to the Department of Water Resources Chicago rain station located in Fair Oaks.

The wholesale connections provided **485.21** AC-FT (92.41%) of surface water and FOWD groundwater wells produced **39.83** AC-FT (7.59%) to meet the total water demand of **525.04** AC-FT.

A graph of total consumption to date versus projected budget target is found in Exhibit A.

A graph of groundwater and surface water use in 2024 to date is found in Exhibit B.

Both the FO-40 and CTP wholesale connections remained open to provide surface water supply to the District.

According to the data provided by SJWD, the recorded volumes from wholesale connections are:

	Forward <u>Flow, AC-FT</u>	Reverse <u>Flow, AC-FT</u>	<u>Total, AC-FT</u>
CTP Connection	287.59	0.00	287.59
FO-40 (39”)	197.62	0.00	197.62
<b>TOTAL FROM SJWD</b>	<b>485.21</b>	<b>0.00</b>	<b>485.21</b>

The average daily flow from wholesale connections for the month of April 2024 was recorded at 3,601 GPM.

The maximum day water demand was reached on April 24, 2024, and was recorded at approximately 8.14 million gallons (MG) with the wholesale connections providing 6.73 MG and FOWD groundwater wells providing 1.41 MG. The minimum day water demand was recorded on April 5, 2024, at 4.16 MG. The average day demand was calculated at 5.63 MG.

The 10-year total average water use for the month of April is 574.58 AC-FT and April 2013 total water demand was recorded at 839.24 AC-FT. The April 2024 total water demand of 525.04 AC-FT represents a decrease of 8.62% from the April 10-year average, a 37.44% decrease from April 2013 consumption, and a 3.36% decrease from 2023 consumption.



During the month of April 2024, all wells performed in accordance with the approved operations plan.

The Skyway Tank and Booster Station operated within normal parameters and in accordance with the seasonal operational schedule.

The production breakdown per groundwater source for the month of April 2024 was:

Town Well	–	10.80 AC-FT
Heather Well	–	12.34 AC-FT
Northridge Well	–	1.23 AC-FT
Madison Well	–	7.67 AC-FT
Skyway Well	–	<u>7.79 AC-FT</u>
<b>TOTAL GROUNDWATER</b>		<b>39.83 AC-FT</b>

A graph of the production of each well to date may be found in Exhibit D.

The water distribution system and water supply facilities performed within design parameters during April. District staff produced water supply in accordance with FOWD Board direction for all of April 2024.

A graph of water consumption per month for 2013, 2023, and 2024 with average trendline is displayed in Exhibit C.

**Fiscal Impact:**

None.

**Policy Implications:**

None.

Exhibit A

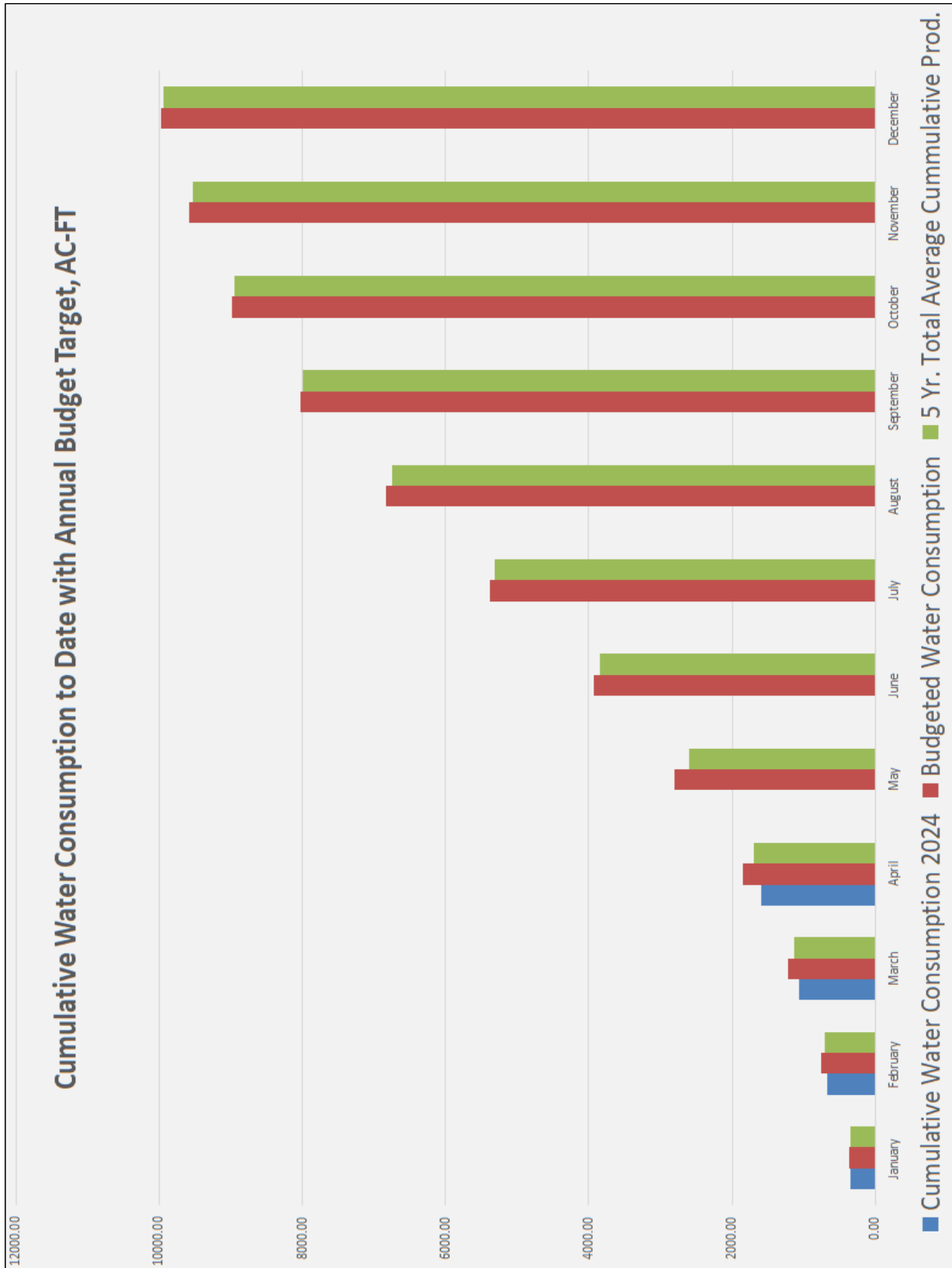

Exhibit B

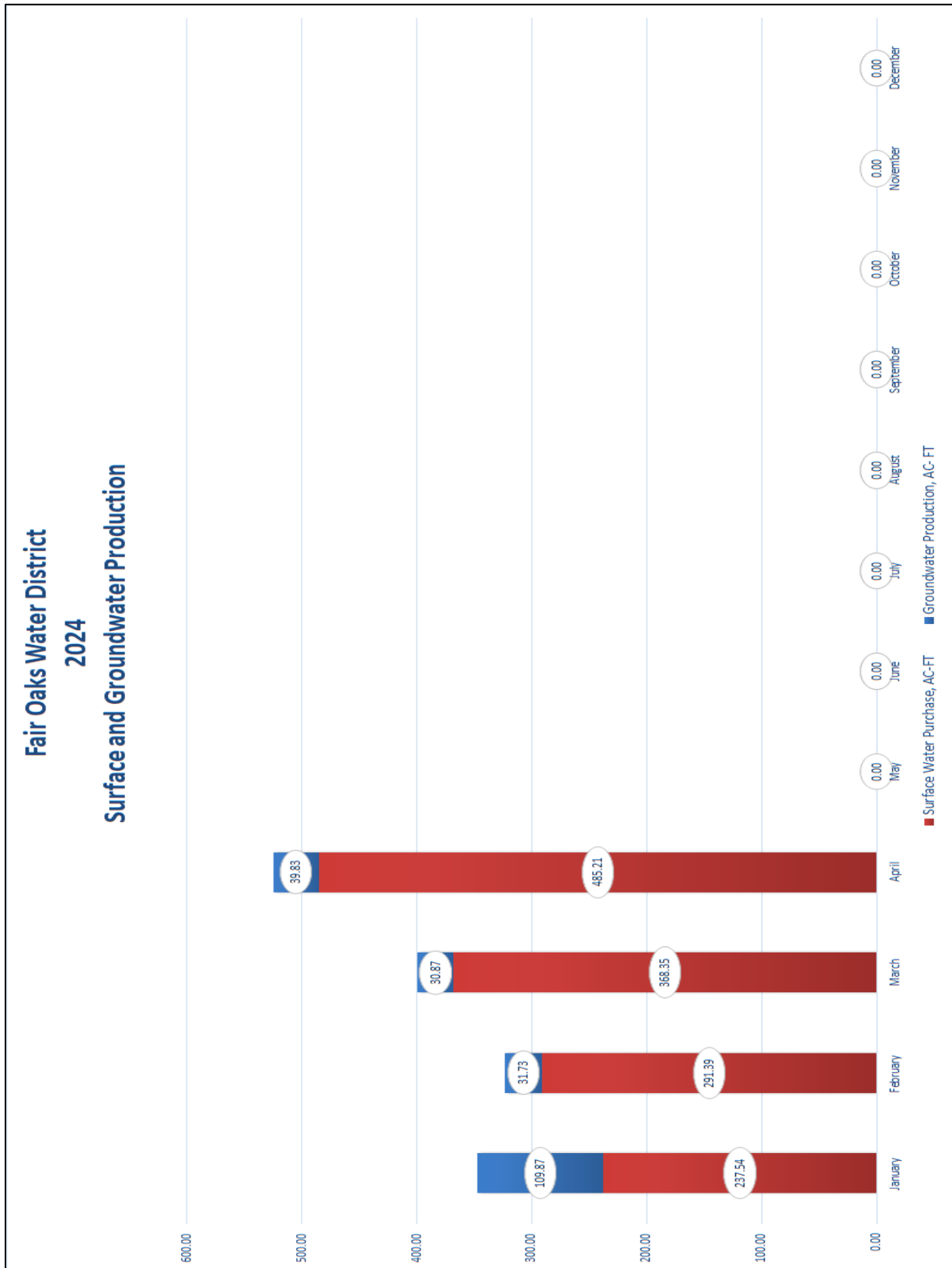

Exhibit C

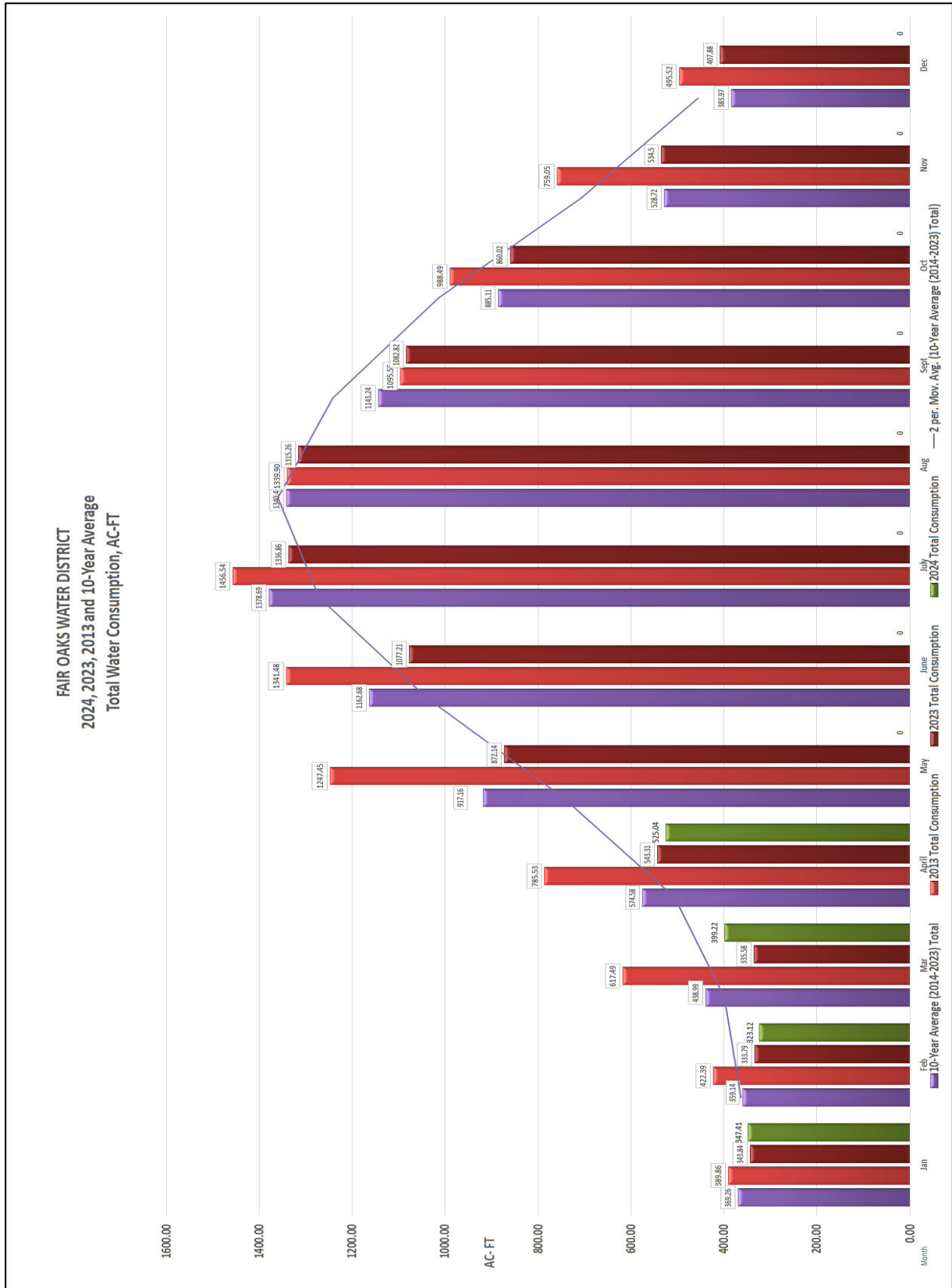
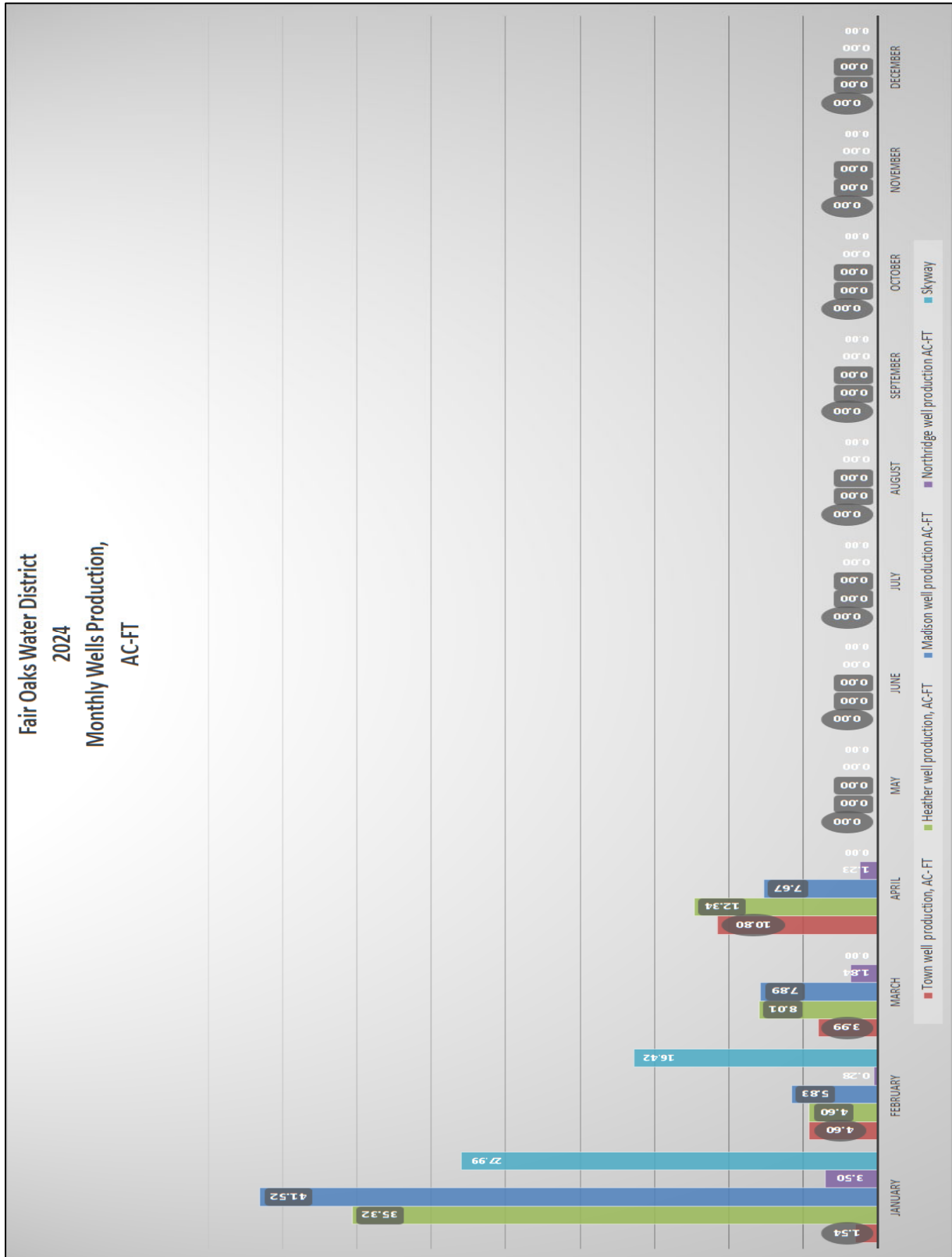

Exhibit D



**May 20, 2024**

**Staff Report Briefing Materials**

**AGENDA ITEM VI.3**

**Discussion and possible action on an updated FOWD Policy No. 1010: “Conflict of Interest”**

---

**AGENDA ITEM VI.3**

REGULAR Board Meeting on May 20, 2024

---

To: Board of Directors  
From: Tom R. Gray  
Date: May 14, 2024  
Subject: Discussion and possible action on an updated FOWD Policy No. 1010:  
“Conflict of Interest”

---

**Recommendation:**

Approve the attached updated FOWD Policy No. 1010: “Conflict of Interest.”

**Discussion:**

Attached is the updated FOWD Policy No. 1010: “Conflict of Interest” that reflects the current process and record keeping of the Statement of Economic Interests (Form 700) for your review.

Sacramento County requires the designated persons to file the Statement of Economic Interests electronically through an electronic solution called eDisclosure on the Sacramento County website. Copies of the completed Form 700 may be obtained as needed through eDisclosure.

Reminders are sent directly from Sacramento County to the designated persons to complete the Form 700.

**Policy Implications:**

An updated FOWD Policy No. 1010: “Conflict of Interest.”

**Fiscal Impact:**

None.



<b>Policy Number:</b>	<b>1010</b>
<b>Policy Title:</b>	<b>Conflict of Interest</b>

1. The Political Reform Act, Government Code Section 81000, et seq., requires state and local government agencies to adopt and promulgate conflict of interest codes. The Fair Political Practices Commission has adopted a regulation, 2 Cal. Code of Regulations, Section 18730, which contains the terms of a standard conflict of interest code, which can be incorporated by reference, and which may be amended to conform to amendments in the Political Reform Act after public notice and hearings conducted by the Fair Political Practices Commission pursuant to the Administrative Procedure Act, Government Code Sections 11370, et seq. ~~Therefore~~Therefore, the terms of 2 Cal. Code of Regs. Section 18730 and any amendments to it duly adopted by the Fair Political Practices Commission are hereby incorporated by reference and, along with this policy, in which directors and employees are designated, and are hereby incorporated by reference and constitute the conflict of interest code of the Fair Oaks Water District.
2. Persons holding designated positions shall file ~~a statements~~Statement of ~~economic Economic interests~~Interests (Form 700) with the ~~Fair Oaks Water District~~Sacramento County. ~~Upon receipt of the economic interest statements, the District Secretary shall make and retain a copy and forward the original of these statements to the Clerk of Sacramento County. The District shall retain statements for all other designated employees.~~The County requires the designated persons to file the Statement of Economic Interests electronically through an electronic solution called eDisclosure on the Sacramento County website.
3. PART I - DESIGNATED ~~EMPLOYEES~~POSITIONS

<u>Position</u>	<u>Disclosure Category</u>
Director 1	1
Director 2	1
Director 3	1
Director 4	1
Director 5	1
General Manager/Secretary	1
Operations Manager	2

Date Adopted: December 28, 1976; Revision Dates: December 8, 1992, August 8, 2000, December 13, 2004, October 11, 2010, August 13, 2012, August 8, 2016, September 12, 2016; June 14, 2021



Finance Manager	2
Technical Services Manager	2
General Counsel for the District	1
Consultant 1*	1
Consultant 2*	1
Consultant 3*	1
Consultant 4*	1
Consultant 5*	1
Consultant 6*	1
Consultant 7*	1
Consultant 8*	1
Consultant 9*	1
Consultant 10*	1

#### 4. PART II - DISCLOSURE CATEGORIES

- 4.1. Disclosure Category 1 – Designated ~~employees-positions~~ must report all investments, business positions in, and income from sources located within the District and all interest in real property located in the District including property located within a two-mile radius of the District or of any property owned or used by the District.
- 4.2. Disclosure Category 2 – Designated ~~positionemployees~~ must report all investments, business positions in and income sources of the type which provide services, supplies, materials, machinery or equipment of the type utilized by the District.
- 4.3. Disclosure Category 3 – Designated ~~employees-positions~~ must report all investments, business positions in and sources of income which are subject to the regulatory permit or licensing authority of the District.
- 4.4. \*Disclosure by Consultants shall be included in the list of ~~employees-positions~~ and disclose pursuant to the broadest disclosure category (Category 1) in the code subject to the following limitation:
- 4.4.1. The ~~District~~General Manager may determine in writing that a particular consultant, although a “designated position” is hired to perform a range of duties that is limited in scope and thus is not required to fully comply with disclosure requirements in this section. The written determination shall

include the basis for this determination and shall be maintained as a public record to the same extent as other disclosures made under the Conflict of Interest Code.

**May 20, 2024**

**Staff Report Briefing Materials**

**AGENDA ITEM VI.4**

**Update and discussion on the Transmission Pipeline Main Break on Pershing Avenue and Chestnut Avenue**

---

## AGENDA ITEM VI.4

REGULAR Board Meeting on May 20, 2024

---

To: Board of Directors  
From: Shawn Huckaby, Operations Manager  
Date: May 15, 2024  
Subject: Update and discussion on the Transmission Pipeline Main Break on Pershing Avenue and Chestnut Avenue

---

### **Recommendation:**

None – information item.

### **Discussion:**

On the morning of April 24, 2024, instrumentation monitored by Fair Oaks Water District (FOWD) staff indicated a significant water pressure drop within the FOWD water system at approximately 5:50 AM. Field investigation by FOWD staff found that a 27-inch water transmission main located at the corner of Pershing Avenue and Chestnut Avenue was leaking and causing significant localized flooding.

- By approximately 6:45 AM the main break was isolated and all FOWD customers were receiving water.
- The water loss is estimated at 1,811,000 gallons.
- By approximately 7:30 AM FOWD employees, with help from a contractor crew immediately started clean-up.
- By approximately 8:00 AM the FOWD customer service staff was responding to water quality calls.
- The only known water quality issues related to the main break are related to aesthetics or clarity of the water in limited locations within the service area.

### Customer Notification:

- The FOWD website was updated with information about the incident and addressed water quality concerns.
- FOWD staff hand delivered a notice to customers in the immediate area of the main break notifying customers about the incident, anticipated construction activity, and estimated schedule for repairs.

### Cause of Main Break:

- The cause of the main break is unknown.
- San Juan Water District (SJWD) staff were exercising transmission main valves located nearby at the intersection of Filbert Avenue and Pershing Avenue when the water main break occurred.
- FOWD staff contacted ACWA JPIA (FOWD insurance provider) for advice on how to proceed with a claim for damages caused by the incident. ACWA JPIA (JPIA)

- 
- recommended that FOWD provide an incident report for review and further direction. ACWA JPIA also provides insurance coverage to the SJWD.
- FOWD and SJWD staff met to review the main break and collaborate on the incident report for JPIA.
  - SJWD staff confirmed at the meeting with FOWD staff that they were exercising main valves nearby when the main break occurred.
  - FOWD and SJWD staff agreed that FOWD would provide an incident report to JPIA and both agencies would wait for a response from JPIA before taking further action related to insurance.
  - FOWD staff sent an incident report to JPIA on May 16, 2024.

#### Damage:

FOWD staff worked with County Representatives to assess the damage caused by the incident. Majority of the water damage, other than clean-up, was limited to the County Right-Of-Way.

- Approximately 11,250 SF of road surface in need of restoration and overlay.
- Approximately 145 feet of curb, gutter, and sidewalk in need of replacement.
- Two curb ramps in need of replacement.
- One drain inlet grate in need of replacement.
- A significant amount of mud and debris covered the road surface for approximately three blocks in the vicinity of the leak.
- FOWD staff collaborated with homeowners to clean driveway/grass that had mud and debris two to three feet up into the private property.
- To date, no reported property damage claims from customers.

#### Contractor Assistance:

FOWD has pre-established contracts with Rawles Engineering (Rawles) and Central Valley Paving (Central Valley) for emergency situations. On the date of the main break incident:

- Rawles immediately responded to the site and performed efficiently by assessing damage and beginning damage restoration – at the pre-established contract price.
- Rawles was instrumental in helping the FOWD team quickly restore the road (temporarily) to a safe condition.
- Central Valley has provided a quote to restore street and sidewalk restoration for \$150,000, significantly below the established contract pricing estimated at \$250,000.
- Central Valley has made the FOWD project a priority.

#### Sacramento County:

- Sacramento County staff oversees County Right-Of-Way surface restoration.
- Sacramento County staff has been supportive to FOWD staff in providing reasonable requirements and timely feedback for street closures, traffic control plans, damage and restoration assessment, and time limits for FOWD to complete the necessary repairs.

**Current Main Break Conditions:**

- The damaged FOWD pipe and immediate surrounding area is secured with a fence.
- Access to the pipe in need of repair is secured with shoring for safe entry by staff.
- Pershing Avenue was safely opened to two-way traffic on April 30, 2024.

**Repair Timeline:**

- FOWD staff have received all parts needed to repair the damaged water main.
- FOWD contracted welder is scheduled to begin main repair on Monday, May 20, 2024.
- The welding install and repair to the water main has a projected completion date of Tuesday, May 21, 2024.
- Once welding is complete, lining the interior and exterior of the pipe repair has a projected completion date of Friday, May 24, 2024.
- Once pressure is re-established in the repaired water main, backfill of the repair excavation site and surface repairs by FOWD staff has a projected completion date of Friday, May 31, 2024.
- FOWD paving contractor, Central Valley, is prepared to start the first week of June with demolition of existing concrete, asphalt, and base material along with installation of concrete forms to replace damaged sidewalk. Once the new concrete has cured, Central Valley will begin demolition and placement of new asphalt plug and overlay.

**Estimated Cost:**

<b>Task</b>	<b>Source</b>	<b>Estimated Cost</b>
FOWD Labor and Materials	FOWD Staff	\$50,000
Rawles Labor and Materials	Rawles Engineering	\$85,000
Welding	Taurus Welding	\$8,000
Barricade / Walls	Capital Barricade	\$5,000
Fencing	Blane Stumpf / NTS	\$2,500
Sampling	BSK	\$500
T-Main Parts	Placer Water Works	\$11,000
Water System Modeling	PBI	\$3,000
Surface Restoration	Central Valley	\$150,000
County Inspection Fees	Sacramento County	\$10,000
<b>Total</b>		<b>\$325,000</b>

Pictures:

















**Policy Implications:**

None.

**Fiscal Impact:**

An initial transfer of \$350,000 from FOWD reserves to cover the unbudgeted work.

Final financial impact has yet to be determined - with FOWD staff anticipating partial recovery of costs for surface restoration from insurance claims.

**May 20, 2024**

**Staff Report Briefing Materials**

**AGENDA ITEM VI.5**

**Update and discussion on the 2023 Consumer Confidence Report**

**AGENDA ITEM VI.5**

REGULAR Board Meeting on May 20, 2024

---

To: Board of Directors  
From: Tom R. Gray  
Date: May 14, 2024  
Subject: Update and discussion on the 2023 Consumer Confidence Report

---

**Recommendation:**

Information item – no staff recommendation.

**Discussion:**

In accordance with State requirements every community water system must publish and distribute information regarding the quality of water they serve customers annually. This is done in a document known as the Consumer Confidence Report (CCR).

The CCR delivered to FOWD customers provides water quality information for both surface water and groundwater. Since a majority of the information contained in the report is the same for all SJWD Wholesale Member Agencies, we join together to produce one CCR for the entire SJWD Wholesale service area at a cost savings to all. The FOWD has developed and delivered the required CCR to FOWD customers in this manner for my entire 20-year tenure as General Manager.

Attached is the most recent CCR providing water quality data for the 2023 year. Please note that this report indicates that water delivered to FOWD customers exceeds all California and Federal standards for water quality.

**Policy Implications:**

None.

**Fiscal Impact:**

None.

# 2023 CONSUMER CONFIDENCE REPORT



**T**his report is published by the San Juan Wholesale Customer Agencies: San Juan Water District, Citrus Heights Water District, Fair Oaks Water District and Orange Vale Water Company. San Juan Water District provides reliable, high-quality water supplies to our customers. We serve nearly 151,000 customers in our retail and wholesale service areas throughout Sacramento and Placer counties. We test our surface water, which comes from the American River watershed, and our local groundwater for microbiological and chemical quality.

The U.S. Environmental Protection Agency and the State Water Resources Control Board maintain strict water quality standards designed to protect customers from waterborne disease organisms and harmful chemicals. As a public water agency, we are required by the U.S. EPA to provide you with an annual Consumer Confidence Report.

This report provides you with information about drinking water quality and how we comply with drinking water quality standards. As your water provider, we are proud to report this year's CCR concludes that, once again, **your drinking water meets all federal and state drinking water standards.**

## WHERE DOES YOUR WATER COME FROM?

Water from the Agencies comes from two sources: treated surface water and groundwater. San Juan Water District diverts and treats surface water from Folsom Lake. This treated water is then distributed to the Agencies. Orange Vale Water Company and San Juan Water District receive 100 percent of their supply from treated surface water. If you are a consumer of Citrus Heights or Fair Oaks water districts, your water is a mixture of treated surface water from San Juan Water District and groundwater from local wells.

SJWD – 100% surface water

OVWC – 100% surface water

CHWD – 90% surface water, 10% groundwater

FOWD – 64.6% surface water, 35.4% groundwater

Source water assessments have been conducted for all the water sources to enable the Agencies to understand the activities that have the greatest potential for contaminating the drinking water supplies. The groundwater sources were assessed in 2002 and the surface water source was evaluated in 2001. New wells for Citrus Heights Water District were assessed in 2008, 2009, and 2015. New wells for Fair Oaks Water District were assessed in 2014 and 2020. These assessments were conducted in accordance with State Water Board guidelines and copies of the complete assessments are available for review at the respective agency offices.

San Juan Water District conducted the evaluation of the Folsom Lake source. It was found to be most vulnerable to potential contamination from the Folsom Lake State Recreation Area facilities, high-density housing and associated activities such as sewer and septic systems and fertilizer, pesticide and herbicide application, as well as illegal activities and dumping. In addition, San Juan Water District conducts a watershed sanitary survey update every five years for the Folsom Lake source. This survey evaluates the water quality and potential contaminating activities in the watershed to ensure adequate treatment is provided and water quality regulations have been met. The most recent update was completed in December 2023. The source water is typically treated using conventional treatment with filtration and disinfection that is designed to remove many contaminants. Again this year, your water meets all federal and state drinking water standards.

Citrus Heights and Fair Oaks water districts conducted assessments of their local groundwater wells. It was found that all the wells are vulnerable to commercial urban activities, such as active and historic gas stations, dry cleaners, leaking underground storage tanks, known contaminant plumes, automobile repair shops, and sewer collection systems, none of which are associated with any detected contaminants. One well for Fair Oaks Water District was found to be vulnerable to irrigation, associated with low level detects of nitrate.

Although Orange Vale Water Company does not currently utilize available local groundwater, assessments found that wells within their service area would be most vulnerable to rural grazing activities.



## WHAT'S IN YOUR WATER?

The sources of drinking water (both tap water and bottled water) include rivers, lakes, streams, ponds, reservoirs, springs, and wells. As water travels over the surface of the land or through the ground, it dissolves naturally-occurring minerals and, in some cases, radioactive material, and can pick up substances resulting from the presence of animals or from human activity.

Contaminants that may be present in the source water include:

- Microbial contaminants, such as viruses and bacteria, that may come from sewage treatment plants, septic systems, agricultural livestock operations, and wildlife.
- Inorganic contaminants, such as salts and metals, that can be naturally-occurring or result from urban stormwater runoff, industrial or domestic wastewater discharges, oil and gas production, mining, or farming.
- Pesticides and herbicides, that may come from a variety of sources such as agriculture, urban stormwater runoff, and residential uses.
- Organic chemical contaminants, including synthetic and volatile organic chemicals, that are byproducts of industrial processes and petroleum production, and can also come from gas stations, urban stormwater runoff, agricultural application, and septic systems.
- Radioactive contaminants, that can be naturally-occurring or be the result of oil and gas production and mining activities.

In order to ensure that tap water is safe to drink, the U.S. Environmental Protection Agency (U.S. EPA) and the State Water Resources Control Board (State Water Board) prescribe regulations that limit the amount of certain contaminants in water provided by public water systems. State Water Board regulations also establish limits for contaminants in bottled water that provide the same protection for public health.

Drinking water, including bottled water, may reasonably be expected to contain at least small amounts of some contaminants. The presence of contaminants does not necessarily indicate that water poses a health risk. More information about contaminants and potential health effects can be obtained by calling the U.S. EPA's Safe Drinking Water Hotline (1-800-426-4791).

## A NOTE FOR SENSITIVE POPULATIONS

Some people may be more vulnerable to contaminants in drinking water than the general population. Immuno-compromised persons such as persons with cancer undergoing chemotherapy, persons who have undergone organ transplants, people with HIV/AIDS or other immune system disorders, some elderly, and infants can be particularly at risk from infections. These people should seek advice about drinking water from their health care providers. U.S. EPA/Centers for Disease Control (CDC) guidelines on appropriate means to lessen the risk of infection by *Cryptosporidium* and other microbial contaminants are available from the Safe Drinking Water Hotline (1-800-426-4791).

## GENERAL INFORMATION ON LEAD

If present, elevated levels of lead can cause serious health problems, especially for pregnant women and young children. Lead in drinking water is primarily from materials and components associated with service lines and home plumbing. The San Juan Family Agencies are responsible for providing high quality drinking water, but cannot control the variety of materials used in plumbing components. When your water has been sitting for several hours, you can minimize the potential for lead exposure by flushing your tap for 30 seconds to 2 minutes before using water for drinking or cooking. If you are concerned about lead in your water, you may wish to have your water tested. Information on lead in drinking water, testing methods, and steps you can take to minimize exposure is available from the Safe Drinking Water Hotline or at <http://www.epa.gov/lead>.

The San Juan Family Agencies also conducts lead tap sampling in schools if requested. One school requested that Citrus Heights Water District conduct lead tap sampling in 2023.

## KEY TO ABBREVIATIONS

PPB	parts per billion or micrograms per liter (µg/L)
PPM	parts per million or milligrams per liter (mg/L)
pCi/L	picocuries per liter
NTU	nephelometric turbidity units
µS/CM	microsiemens per centimeter
ND	not detected
NR	not required
N/A	not applicable

## WATER QUALITY DEFINITIONS

**Maximum Contaminant Level (MCL)** – The highest level of a contaminant that is allowed in drinking water. Primary MCLs are set as close to the PHGs (or MCLGs) as is economically and technologically feasible. Secondary MCLs are set to protect the odor, taste, and appearance of drinking water.

**Public Health Goal (PHG)** – The level of a contaminant in drinking water below which there is no known or expected risk to health. PHGs are set by the California Environmental Protection Agency.

**Maximum Contaminant Level Goal (MCLG)** – The level of a contaminant in drinking water below which there is no known or expected risk to health. MCLGs are set by the U.S. Environmental Protection Agency.

**Maximum Residual Disinfectant Level (MRDL)** – The highest level of a disinfectant allowed in drinking water. There is convincing evidence that addition of a disinfectant is necessary for control of microbial contaminants.

**Maximum Residual Disinfectant Level Goal (MRDLG)** – The level of a drinking water disinfectant below which there is no known or expected risk to health. MRDLGs do not reflect the benefits of the use of disinfectants to control microbial contaminants.

**Primary Drinking Water Standard (PDWS)** – MCLs, MRDLs and Treatment Techniques (TTs) for contaminants that affect health, along with their monitoring and reporting requirements.

**Treatment Technique (TT)** – A required process intended to reduce the level of a contaminant in drinking water.

**Regulatory Action Level (AL)** – The concentration of a contaminant which, if exceeded, triggers treatment or other requirements that a water system must follow.

**Notification Level (NL)** – Health-based advisory level set by the State Water Board for constituents with no MCL. This is not an enforceable standard, although requirements and recommendations may apply if detected above this level.

## UNREGULATED CONTAMINANT MONITORING RULE (UCMR) RESULTS

U.S. EPA requires public water systems to collect data for unregulated constituents in drinking water supplies under the Unregulated Contaminant Monitoring Rule program. Currently, these constituents have no drinking water standards but may be regulated in the future. The fourth round (UCMR4) was conducted from 2018 – 2020 and the fifth round (UCMR5) began in 2022.

More information on the UCMRs can be found at <https://www.epa.gov/dwucmr>. For UCMR4, all the San Juan Family Agencies conducted sampling in 2018 and 2019. Several constituents were detected, none at any level of human health concern, see summary table below. For UCMR5, San Juan Water District, Fair Oaks Water District, and Orange Vale Water Company conducted monitoring in 2023 and no constituents were detected.

## UCMR4 DETECTED CONSTITUENT SUMMARY

Constituent	Range (µg/L)	Average (µg/L)	Human Health Advisory	Potential Sources
Manganese	ND – 1.9 <sup>1</sup> ND – 3.24 <sup>2</sup> 1.8 – 9.92 <sup>3</sup> 0.56 – 4.9 <sup>4</sup>	1.9 <sup>1</sup> 1.05 <sup>2</sup> 3.81 <sup>3</sup> 2.72 <sup>4</sup>	U.S. EPA Lifetime Health Advisory - 300 µg/L State Board Notification Level – 500 µg/L	Naturally-occurring metal
HAA5	ND – 25 <sup>1</sup> 18.97 – 31.6 <sup>2</sup> 19.46 – 21.22 <sup>3</sup> 22.8 – 33 <sup>4</sup>	6.7 <sup>1</sup> 21.14 <sup>2</sup> 20 <sup>3</sup> 27.1 <sup>4</sup>	State Water Board Maximum Contaminant Level – 60 µg/L	By-product of drinking water disinfection
HAA6Br	ND – 1.44 <sup>4</sup>	1.03 <sup>4</sup>	None	By-product of drinking water disinfection
HAA9	ND – 17 <sup>1</sup> 15.57 – 32.62 <sup>2</sup> 20.04 – 22.21 <sup>3</sup> 23.42 – 34.38 <sup>4</sup>	14.5 <sup>1</sup> 24.66 <sup>2</sup> 20.85 <sup>3</sup> 28.11 <sup>4</sup>	None	By-product of drinking water disinfection
Bromide	ND – 32 <sup>1</sup>	24.7 <sup>1</sup>	None	Naturally-occurring compound

1 – Fair Oaks Water District (wells, treated surface water from SJWD, and distribution system – 2018 and 2019)

2 – San Juan Water District (treated surface water and distribution system – 2019)

3 – Citrus Heights Water District (wells, treated surface water from SJWD, and distribution system – 2019)

4 – Orange Vale Water Company (treated surface water from SJWD and distribution system – 2019)

# 2023 TABLE OF DETECTED CONSTITUENTS

DETECTED PRIMARY DRINKING WATER CONSTITUENTS regulated to protect your health													
CONSTITUENT	UNITS	PHG or (MCLG) or (MRDLG)	MCL or (MRDL)	San Juan Surface Water Including Orange Vale Water Company(a)			Citrus Heights Groundwater			Fair Oaks Groundwater			MAJOR SOURCES
				RANGE	AVERAGE	YEAR SAMPLED	RANGE	AVERAGE	YEAR SAMPLED	RANGE	AVERAGE	YEAR SAMPLED	
Arsenic	PPB	0.004	10	ND	ND	2022	ND - 2.1	ND	2022	ND - 3.3	ND	2021	Erosion of natural deposits; runoff from orchards; glass and electronics production waste
Barium	PPM	2	1	ND	ND	2022	ND - 0.13	ND	2022	ND	ND	2021	Erosion of natural deposits and wastes from metal refineries
Fluoride	PPM	1	2.0	ND	ND	2023	ND - 0.15	0.1	2022	ND - 0.11	ND	2021	Erosion of natural deposits; discharge from fertilizer and aluminum factories
Nitrate (as N)	PPM	10	10	ND	ND	2023	1.3 - 3.4	2.6	2023	ND - 3.4	ND	2023	Runoff and leaching from fertilizer use; leaching from septic tanks and sewage; erosion of natural deposits
Uranium	pCi/L	0.43	20	NR	N/A	N/A	ND - 1.7	ND	2022	ND	ND	2018	Erosion of natural deposits
Chlorine Residual - distribution system	PPM	[4]	[4]	0.11 - 1.43 (0.18 - 1.01)	0.67 (0.65)	2023	0.3 - 1.18	0.74	2023	0.2 - 0.83	0.47	2023	Drinking water disinfectant added for treatment
Total Trihalomethanes - distribution system	PPB	N/A	80	47 - 87 (30 - 51)	62.9 (40)	2023	5 - 47	43	2023	19 - 56	45.3	2023	By-product of drinking water disinfection
Haloacetic Acides - distribution system	PPB	N/A	60	23 - 51 (22 - 41)	38.1 (29)	2023	ND - 44	35	2023	ND - 39	30.3	2023	By-product of drinking water disinfection
Control of Disinfection By-Product Precursors (TOC) (treated water) (b)	PPM	N/A	TT = 2	0.81 - 1.68	1.11	2023	NR	N/A	N/A	NR	N/A	N/A	Various natural and manmade sources
CONSTITUENT	UNITS	PHG or (MCLG)	MCL	LEVEL FOUND			YEAR SAMPLED	LEVEL FOUND			YEAR SAMPLED	MAJOR SOURCES	
Turbidity (b)	NTU	N/A	TT = 1 NTU	0.081			2023	NR			N/A	NR	
	% Samples	N/A	TT = ≤0.3 NTU	100			2023	NR			N/A	NR	
CONSTITUENT	UNITS	PHG or (MCLG)	AL	90th PERCENTILE	# SAMPLED/ # EXCEED AL	YEAR SAMPLED	90th PERCENTILE	# SAMPLED/ # EXCEED AL	YEAR SAMPLED	90th PERCENTILE	# SAMPLED/ # EXCEED AL	YEAR SAMPLED	MAJOR SOURCES
Lead (c)	PPB	0.2	15	ND (ND)	30/0 (30/0)	2021 (2021)	ND	30/0	2021	ND	30/0	2022	Internal corrosion of household water plumbing systems; discharges from industrial manufacturers; erosion of natural deposits
Copper	PPM	0.3	1.3	0.055 (0.1)	30/0 (30/0)	2021 (2021)	0.083	30/0	2021	0.067	30/0	2022	Internal corrosion of household plumbing systems; erosion of natural deposits; leaching from wood preservatives
DETECTED SECONDARY DRINKING WATER CONSTITUENTS regulated for aesthetic qualities													
CONSTITUENT	UNITS	PHG or (MCLG)	MCL	San Juan Surface Water Including Orange Vale Water Company			Citrus Heights Groundwater			Fair Oaks Groundwater			MAJOR SOURCES
				RANGE	AVERAGE	YEAR SAMPLED	RANGE	AVERAGE	YEAR SAMPLED	RANGE	AVERAGE	YEAR SAMPLED	
Total Dissolved Solids	PPM	N/A	1,000	29 - 51	38.4	2023	230 - 310	262.5	2022	110 - 190	156	2021	Runoff/leaching from natural deposits
Specific Conductance	µS/CM	N/A	1,600	51 - 93	67.9	2023	300 - 450	372.5	2022	120 - 230	194	2021	Substances that form ions when in water
Color	UNITS	N/A	15	ND	ND	2022	ND - 5	3.75	2022	ND	ND	2021	Naturally-occurring organic materials
Odor	UNITS	N/A	3	ND	ND	2022	ND	ND	2022	ND - 2.3	1.1	2021	Naturally-occurring organic materials
Manganese	PPB	N/A	50	ND	ND	2022	ND - 26	ND	2022	ND	ND	2021	Leaching from natural deposits
Sulfate	PPM	N/A	500	4.5	4.5	2022	8.2 - 14	11.8	2022	3.7 - 16	9.7	2021	Runoff/leaching from natural deposits
Chloride	PPM	N/A	500	3.2	3.2	2022	16 - 38	22.3	2022	3.5 - 7	5.3	2021	Runoff/leaching from natural deposits
Turbidity	NTU	N/A	5	0.013 - 0.081	0.017	2023	0.16 - 0.33	0.23	2022	ND - 0.19	0.048	2021	Soil runoff
DETECTED UNREGULATED DRINKING WATER CONSTITUENTS (d)													
CONSTITUENT	UNITS	PHG or (MCLG)	MCL	San Juan Surface Water Including Orange Vale Water Company			Citrus Heights Groundwater			Fair Oaks Groundwater			MAJOR SOURCES
				RANGE	AVERAGE	YEAR SAMPLED	RANGE	AVERAGE	YEAR SAMPLED	RANGE	AVERAGE	YEAR SAMPLED	
Bicarbonate Alkalinity	PPM	N/A	NONE	9 - 20	14.8	2023	110 - 150	130	2022	54 - 100	79.6	2021	Bicarbonate alkalinity is the measure of the capacity of water or any solution to neutralize or "buffer" acids, represented as the bicarbonate ion.
Hardness	PPM	N/A	NONE	17	17	2022	98 - 160	134.5	2022	53 - 94	74	2021	Hardness is the sum of polyvalent cations present in the water, generally naturally occurring magnesium and calcium.
Sodium	PPM	N/A	NONE	2.1	2.1	2022	16 - 24	20.3	2022	5.3 - 16	10.2	2021	Naturally occurring salt in the water
Calcium	PPM	N/A	NONE	4.5	4.5	2022	22 - 38	30.5	2022	13 - 22	17.8	2021	Erosion of natural deposits
Magnesium	PPM	N/A	NONE	1.3	1.3	2022	11 - 16	14.3	2022	4.8 - 9.6	5.7	2021	Erosion of natural deposits

(a) - Data for OVWC Distribution System is shown in parenthesis.

(b) - Only surface water sources must comply with PDWS for Control of Disinfection By-Product Precursors and turbidity. Turbidity is a measure of the cloudiness of water. We monitor for it because it is a good indicator of the effectiveness of our filtration system.

(c) - One school requested monitoring for lead from Citrus Heights Water District in 2023

(d) - Unregulated contaminant monitoring helps determine where certain contaminants occur and whether they need to be regulated.

The State allows us to monitor for some contaminants less than once per year because the concentrations of these contaminants do not change frequently. Some of our data, though representative, are more than one year old.



## 2023 CONSUMER CONFIDENCE REPORT

Yearly Water Quality Report

### San Juan Wholesale Customer Agencies

P.O. Box 2157  
Granite Bay, CA 95746

### Board of Directors

Manuel Zamorano	Dan Rich
Edward J. "Ted" Costa	Pamela Tobin
Kenneth H. Miller	

Este informe contiene información muy importante sobre su agua potable. Tradúzcalo o hable con alguien que lo entienda bien. Favor de comunicarse San Juan Family Agency para asistirlo en español.

Этот отчет содержит важную информацию о вашей питьевой воде. Пожалуйста, свяжитесь с San Juan Family Agency для получения помощи на русском языке.

## CONTACT US

If you have any questions about this report or your water supply, please contact your local water provider. Each of the member agencies holds monthly board meetings that are open to the public as indicated below.



### Contact Person:

Greg Turner  
(916) 791-1715  
gturner@sjwd.org  
www.sjwd.org

### Board Meetings:

3rd Wednesday each month  
6:00 p.m.  
9935 Auburn-Folsom Road  
Granite Bay

### Contact Person:

Brian Hensley  
(916) 725-6873  
bhensley@chwd.org  
www.chwd.org

### Board Meetings:

4th Tuesday each month  
6:30 p.m.  
6230 Sylvan Road  
Citrus Heights

### Contact Person:

Paul Siebensohn  
(916) 967-5723  
psiebensohn@fowd.com  
www.fowd.com

### Board Meetings:

3rd Monday every month  
6:30 p.m.  
10326 Fair Oaks Boulevard  
Fair Oaks

### Contact Person:

Mark DuBose  
(916) 988-1693  
mdubose@orangevalewater.com  
www.orangevalewater.com

### Board Meetings:

1st Tuesday each month  
4:00 p.m.  
9031 Central Avenue  
Orangevale

**May 20, 2024**

**Staff Report Briefing Materials**

**AGENDA ITEM VI.6**

**Update and discussion on the candidate statement costs for the November 2024  
General Election**

---

**AGENDA ITEM VI.6**

REGULAR Board Meeting on May 20, 2024

---

To: Board of Directors  
From: Tom R. Gray  
Date: May 14, 2024  
Subject: Update and discussion on the candidate statement costs for the November 2024 General Election

---

**Recommendation:**

Information only item – staff has no recommendation.

**Discussion:**

At the March 18, 2024 Regular Board Meeting, the Board adopted the FOWD Resolution No. 24-01: “A Resolution of the Board of Directors of the Fair Oaks Water District Calling for a General Election.”

The adopted Resolution No. 24-01 indicated that the Candidate shall pay at the Voter Registration and Elections Office for the publication of the candidate’s statement, pursuant to Elections Code §13307. The limitation on the number of words that a candidate may use in their candidate statement is 200.

The candidate statement costs for all FOWD Board Divisions that will be included in November 2024 General election are summarized below:

Fair Oaks Water District, Division 3	\$380
Fair Oaks Water District, Division 4	\$370
Fair Oaks Water District, Division 5	\$350

The newly formed San Juan Water District Division 4 essentially represents the FOWD service area and does not have an incumbent to run. Should an individual have interest in running for the San Juan Water District, Division 4 open seat, the candidate statement cost is \$1,150.

Please see the attached from the County of Sacramento for your information.

**Policy Implications:**

None.

**Fiscal Impact:**

None.

# CANDIDATE STATEMENT COSTS

<b>Runoff Contest</b>			
	<b>Cost</b>	<b>Shared District</b>	<b>Word / Paragraph Limit</b>
City of Sacramento, Mayor	\$12,220.00	No	200 words 5 paragraphs
City of Sacramento, District 2	\$1,230.00	No	
<b>Top Two Contest</b>			
	<b>Cost</b>	<b>Shared District</b>	<b>Word / Paragraph Limit</b>
Congressional, District 3	\$3,700.00	Yes	250 words 6 paragraphs
Congressional, District 6	\$17,850.00	No	
Congressional, District 7	\$17,150.00	Yes	
<b>State Senator</b>			
	<b>Cost</b>	<b>Shared District</b>	<b>Word / Paragraph Limit</b>
Senate, District 3	\$300.00	Yes	250 words 6 paragraphs
<b>Member of the State Assembly</b>			
	<b>Cost</b>	<b>Shared District</b>	<b>Word / Paragraph Limit</b>
Assembly, District 6	\$12,300.00	No	250 words 6 paragraphs
Assembly, District 7	\$12,650.00	No	
Assembly, District 9	\$1,650.00	Yes	
Assembly, District 10	\$12,250.00	No	
Assembly, District 11	\$200.00	Yes	
<b>Local Offices</b>			
<b>County Board of Education</b>			
	<b>Cost</b>	<b>Shared District</b>	<b>Word / Paragraph Limit</b>
Placer County Board of Education, Area 2	\$710.00	Yes	200 words 5 paragraphs
<b>Community Colleges</b>			
	<b>Cost</b>	<b>Shared District</b>	<b>Word / Paragraph Limit</b>
Los Rios Community College District, Area 3	\$2,930.00	Yes	200 words 5 paragraphs
Los Rios Community College District, Area 4	\$3,380.00	No	
Los Rios Community College District, Area 5	\$5,760.00	No	
Los Rios Community College District, Area 7	\$6,520.00	No	
San Joaquin Delta Community College District, Area 5	\$630.00	Yes	
Sierra Joint Community College District, Area 3	\$500.00	Yes	

# CANDIDATE STATEMENT COSTS

Schools	Cost	Shared District	Word / Paragraph Limit
Arcohe Union School District	\$280.00	No	200 words 5 paragraphs
Center Joint Unified School District	\$790.00	Yes	
Dry Creek Joint Elementary School District	\$710.00	Yes	
Elk Grove Unified School District, Area 1	\$1,130.00	No	
Elk Grove Unified School District, Area 3	\$1,180.00	No	
Elk Grove Unified School District, Area 6	\$1,450.00	No	
Elk Grove Unified School District, Area 7	\$1,690.00	No	
Elverta Joint Elementary School District	\$200.00	Yes	
Folsom Cordova Unified School District, Area 2	\$980.00	No	
Folsom Cordova Unified School District, Area 4	\$780.00	No	
Galt Joint Union Elementary School District, Area 3	\$270.00	Yes	
Galt Joint Union Elementary School District, Area 4	\$290.00	No	
Galt Joint Union High School District, Area 3	\$240.00	Yes	
Galt Joint Union High School District, Area 5	\$370.00	No	
Natomas Unified School District, Area 2	\$530.00	No	
Natomas United School District, Area 3	\$560.00	No	
Natomas United School District, Area 5	\$590.00	No	
Robla Unified School District	\$550.00	No	
Roseville Joint Union High School District, Area 1	\$710.00	No	
Sacramento City Unified School District, Area 3	\$1,380.00	No	
Sacramento City Unified School District, Area 4	\$1,110.00	No	
Sacramento City Unified School District, Area 5	\$1,120.00	No	
Sacramento City Unified School District, Area 7	\$1,150.00	No	
San Juan Unified School District, Area 1	\$1,010.00	No	
San Juan Unified School District, Area 2	\$1,320.00	No	
San Juan Unified School District, Area 4	\$1,420.00	No	

# CANDIDATE STATEMENT COSTS

Cities	Cost	Shared District	Word / Paragraph Limit
City of Citrus Heights, District 1	\$590.00	No	200 words 5 paragraphs
City of Citrus Heights, District 3	\$600.00	No	
City of Elk Grove, Mayor	\$4,960.00	No	
City of Elk Grove, District 1	\$1,370.00	No	
City of Elk Grove, District 3	\$1,280.00	No	
City of Folsom, District 2	\$580.00	No	
City of Folsom, District 4	\$520.00	No	
City of Galt, Councilmember	\$780.00	No	
City of Galt, City Clerk	\$780.00		
City of Galt, City Treasurer	\$780.00		
City of Isleton, Councilmember	\$150.00	No	
City of Isleton, City Clerk	\$150.00		
City of Isleton, City Treasurer	\$150.00		
City of Rancho Cordova, District 1	\$500.00	No	
City of Rancho Cordova, District 3	\$460.00	No	
City of Rancho Cordova, District 4	\$490.00	No	
<b>Community Services Districts</b>	<b>Cost</b>	<b>Shared District</b>	<b>Word / Paragraph Limit</b>
Cosumnes Community Services District, Division 1	\$1,180.00	No	200 words 5 paragraphs
Cosumnes Community Services District, Division 3	\$1,280.00	No	
Cosumnes Community Services District, Division 4	\$1,150.00	No	
Rancho Murieta Community Services District	\$350.00	No	
San Juan Water District, Division 2	\$630.00	Yes	
San Juan Water District, Division 4	\$1,150.00	No	
<b>Fire Protection Districts</b>	<b>Cost</b>	<b>Shared District</b>	<b>Word / Paragraph Limit</b>
Courtland Fire Protection District	\$160.00	No	200 words 5 paragraphs
Delta Fire Protection District	\$150.00	No	
Herald Fire Protection District	\$230.00	No	
Pacific Fruitridge Fire Protection District	\$710.00	No	
River Delta Fire District	\$170.00	No	
Sacramento Metropolitan Fire Protection District, Division 2	\$2,060.00	Yes	
Sacramento Metropolitan Fire Protection District, Division 4	\$2,050.00	No	
Sacramento Metropolitan Fire Protection District, Division 5	\$2,490.00	No	
Sacramento Metropolitan Fire Protection District, Division 6	\$1,640.00	No	
Sacramento Metropolitan Fire Protection District, Division 8	\$2,030.00	No	
Walnut Grove Fire Protection District	\$180.00	No	
Wilton Fire Protection District	\$370.00	No	



# CANDIDATE STATEMENT COSTS

<b>Municipal Utility Districts</b>	<b>Cost</b>	<b>Shared District</b>	<b>Word / Paragraph Limit</b>
Sacramento Municipal Utility District, Ward 1	\$5,860.00	No	200 words 5 paragraphs
Sacramento Municipal Utility District, Ward 2	\$6,080.00	No	
Sacramento Municipal Utility District, Ward 5	\$5,430.00	No	
<b>Flood Control Districts</b>	<b>Cost</b>	<b>Shared District</b>	<b>Word / Paragraph Limit</b>
American River Flood Control District, Division 4	\$950.00	No	200 words 5 paragraphs
American River Flood Control District, Division 5	\$1,200.00		
<b>Recreation and Park Districts</b>	<b>Cost</b>	<b>Shared District</b>	<b>Word / Paragraph Limit</b>
Arcade Creek Recreation and Park District	\$600.00	No	200 words 5 paragraphs
Arden Manor Recreation and Park District	\$330.00	No	
Arden Park Recreation and Park District	\$310.00	No	
Cordova Recreation and Park District, District 3	\$890.00	No	
Cordova Recreation and Park District, District 4	\$790.00	No	
Fair Oaks Recreation and Park District	\$1,190.00	No	
Fulton-El Camino Recreation and Park District	\$790.00	No	
North Highlands Recreation and Park District	\$1,060.00	No	
Orangevale Recreation and Park District	\$1,110.00	No	
Rio Linda-Elverta Recreation and Park District	\$680.00	No	
Southgate Recreation and Park District, Division 1	\$550.00	No	
Southgate Recreation and Park District, Division 2	\$640.00	No	
Southgate Recreation and Park District, Division 4	\$790.00	No	
Southgate Recreation and Park District, Division 5	\$830.00	No	
<b>Resource Conservation Districts</b>	<b>Cost</b>	<b>Shared District</b>	
Florin Resource Conservation District	\$8,720.00	No	200 words 5 paragraphs

# CANDIDATE STATEMENT COSTS

Water and Irrigation Districts	Cost	Shared District	Word / Paragraph Limit
Carmichael Water District, Division 1	\$380.00	No	200 words 5 paragraphs
Carmichael Water District, Division 2	\$340.00	No	
Carmichael Water District, Division 4	\$350.00	No	
Citrus Heights Water District, Division 1	\$660.00	No	
Del Paso Manor Water District	\$270.00	No	
Fair Oaks Water District, Division 3	\$380.00	No	
Fair Oaks Water District, Division 4	\$370.00	No	
Fair Oaks Water District, Division 5	\$350.00	No	
Florin County Water District, Director	\$350.00	No	
Galt Irrigation District, Division 2	\$170.00	No	
Galt Irrigation District, Division 3	\$180.00	No	
Galt Irrigation District, Division 4	\$150.00	No	
Galt Irrigation District, Division 5	\$190.00	No	
Rio Linda/Elverta Community Water District	\$580.00	No	
Sacramento Suburban Water District, Division 1	\$950.00	No	
Sacramento Suburban Water District, Division 2	\$870.00	No	
Geologic Hazard Abatement District	Cost	Shared District	
Delta Region Geologic Hazard Abatement District	\$150.00	No	200 words 5 paragraphs



---

**May 20, 2024**

**Staff Report Briefing Materials**

**AGENDA ITEM VI.7**

**Update and discussion on State proposed "Water Budgets" for FOWD customers**

**AGENDA ITEM VI.7**

REGULAR Board Meeting on May 20, 2024

---

To: Board of Directors  
From: Tom R. Gray  
Date: May 15, 2024  
Subject: Update and discussion on State proposed “Water Budgets” for FOWD customers

---

**Recommendation:**

Information item – no staff recommendation.

**Discussion:**

Urban water agencies in California are required to comply with water efficiency standards that are being developed from State Senate Bill 606 and State Assembly Bill 1688, touted as the framework for *Making Conservation a California Way of Life*. The proposed new regulations aim to squeeze additional water from urban water users who have been making significant strides to conserve water since 2013 – it can be documented that average FOWD customer water demand is currently over 20 percent less when compared to 2013. The new standards have yet to be finalized but are anticipated to be in adopted in July of this year.

The Regional Water Authority will be giving a presentation regarding proposed “water budgets” on May 16, 2014. Slides for that presentation are attached for your information. The data presented in the slides contains provisional data which are known to have errors, but the presentation provides a representation of what may be expected.

**Policy Implications:**

None at this time with potential future Policy impacts.

**Fiscal Impact:**

None at this time with potential future financial impact.



BE WATER SMART  
**Outline**

- SB 606/AB 1668 Supplier Water Budgets
- Non-Volumetric Requirements
- Reporting, Compliance and Enforcement
- Outstanding Concerns
- RWA Leadership and Assistance
- Next Steps



**SB 606 and AB 1668 (2018)**

**Water Agency Water Use Objective =**

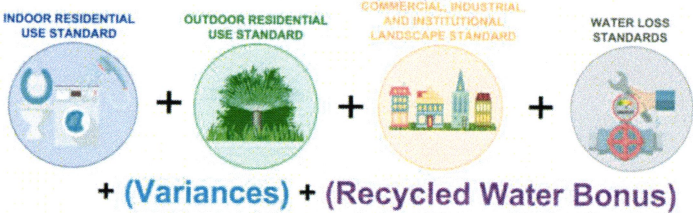

BE WATER SMART  
**Compliance**



A couple of key points:

- Water targets will be set based on the overall water use of water provider (targets will not be set for individual customers!)
- Water agencies do not need to meet each standard individually but can choose what strategies to deploy to meet overall objective.  
*EXCEPT....Maybe water loss???*
- Targets rolled up to XXXX gallons and will be compared to relevant meter data to determined "over" or "under" budget

DRAFT - Only use as estimate of savings needed at timesteps.  
Does not reflect total budgets and future weather inputs.

RWA Urban Water Supplier	2025	2030	2035	2040
California American Water Company - Sacramento District	0%	0%	0%	0%
Carmichael Water District	0%	0%	-8%	-15%
Citrus Heights Water District	0%	0%	-1%	-9%
El Dorado Irrigation District	0%	0%	0%	0%
Elk Grove Water District	0%	0%	0%	0%
Fair Oaks Water District	-4%	-6%	-20%	-26%
Folsom	-19%	-21%	-29%	-32%
Georgetown Divide Public Utility District	0%	0%	0%	0%
Golden State Water Company - Cordova	-22%	-24%	-32%	-36%
Lincoln	-1%	-4%	-15%	-20%
Nevada Irrigation District	0%	0%	0%	0%
Orangevale Water Company	0%	0%	0%	-1%
Placer County Water Agency	0%	0%	-5%	-11%
Roseville	0%	0%	-3%	-7%
Sacramento	0%	0%	-9%	-14%
Sacramento County Water Agency	0%	0%	0%	0%
Sacramento Suburban Water District	0%	0%	-7%	-13%
San Juan Water District	0%	0%	-10%	-18%
West Sacramento	-4%	-8%	-17%	-21%
Yuba City	0%	-1%	-11%	-15%
<b>Average Reduction</b>	<b>-3%</b>	<b>-3%</b>	<b>-8%</b>	<b>-12%</b>

## DRAFT Submit to change

Estimated Reductions Required \* based on the 2040 standards

Degree of reduction (relative to the subset of uses comprising the objective)	# of Suppliers	% of Suppliers	Population Served	% of Covered Population
No Reduction required	121	31%	11,372,900	31%
Less Than 5% Reduction	31	8%	3,842,897	10%
5-10% Reduction	50	13%	8,328,439	23%
10-20% Reduction	84	21%	6,437,314	18%
20-30% Reduction	61	15%	4,573,272	12%
Greater Than 30% Reduction	49	12%	2,163,090	6%
<b>Total</b>	<b>396</b>	<b>100%</b>	<b>36,715,496</b>	<b>100%</b>

\* For many suppliers, impacts will smaller, in some cases significantly so, because of corrected data, the budgets associated with variances and special landscape areas, the alternative compliance pathways, and long-term trends (e.g., population growth and the efficiency gains that will occur regardless of the proposed regulation).

DRAFT - Only use as estimate of savings needed at timesteps.  
Does not reflect total budgets and future weather inputs.

RWA Urban Water Supplier	2025	2030	2035
California American Water	14%	-11%	-16%
Carmichael Water District	11%	-13%	-21%
Citrus Heights Water District	17%	-6%	-13%
El Dorado Irrigation District	40%	8%	0%
Elk Grove Water District	4%	-20%	-26%
Fair Oaks Water District	-5%	-26%	-32%
Folsom	-22%	-33%	-36%
Georgetown Divide Public Utility District	0%	0%	0%
Golden State Water Company	-22%	-34%	-37%
Lincoln	-7%	-22%	-27%
Nevada Irrigation District	0%	0%	0%
Orangevale Water Company	30%	1%	-7%
Placer County Water Agency	-2%	-20%	-26%
Roseville	1%	-11%	-15%
Sacramento	-2%	-19%	-23%
Sacramento County Water Agency	2%	-14%	-19%
Sacramento Suburban Water District	3%	-16%	-21%
San Juan Water District	4%	-19%	-26%
West Sacramento	-13%	-27%	-31%
Yuba City	-4%	-21%	-25%
<b>Average Reduction</b>	<b>-10%</b>	<b>-19%</b>	<b>-24%</b>

BE WATER SMART

## Non-volumetric Requirements

- Classification of CII Sector Accounts
- CII Sector Specific Best Management Practices
  - Outreach, Technical Assistance and Education, Incentives, Landscape Programs, Collaboration/Coordination and Operational
- Large Landscapes > 0.5 acres – DIM installation or In-Lieu Tech

### Classification Categories

- |                                  |                         |
|----------------------------------|-------------------------|
| 1. Banking/Financial Service     | 13. Retail              |
| 2. Education                     | 14. Technology/Science  |
| 3. Entertainment/Public Assembly | 15. Services            |
| 4. Food Sales and Service        | 16. Utility             |
| 5. Healthcare                    | 17. Warehouse/Storage   |
| 6. Lodging                       | 18. Other               |
| 7. Manufacturing/Industrial      | 19. CII Laundries       |
| 8. Mixed Use Properties          | 20. Landscapes with DIM |
| 9. Offices                       | 21. Water recreation    |
| 10. Parking                      | 22. Car wash            |
| 11. Public Services              |                         |
| 12. Religious Worship            |                         |

BE WATER SMART

## Reporting, Compliance and Enforcement

- January 1<sup>st</sup> annual reporting on water budget versus water use and non-volumetric activities
  - Extensive
  - Coordinated with water loss audit
- Various enforcement options like information orders, written notices, conservation order and civil liability (fine) can be leverage over the next few years.
  - State Water Board considering pushing out enforcement dates due to regulation development delay

BE WATER SMART

## Primary Outstanding Concerns

### Outdoor

- 2040 budget - design standard
- Tree health impacts
- Less time than current draft

### Affordability

- Not remotely cost effective
- Not enough grant funding
- Increase in rates – fixed costs
- Impact on DAC customers
- Staffing needs



BeWaterSmart.info

BE WATER SMART

## Primary Outstanding Concerns

### Reporting

- Fiscal versus calendar year
- Purpose
- Coordinated with other reporting requirements

### Feasibility Concerns

- Heavily relies on customer behavior for compliance
- Need for enforcement policy (SB 1110)
- Need for improved SWB/DWR collaboration
- Data availability and quality
- Too much too soon for too much \$\$



BeWaterSmart.info

BE WATER SMART

## RWA Leadership

- Indoor: ACWA workgroup, RWA example in coalition letter, SWB and DWR meetings
- Outdoor: ACWA workgroup, Land IQ analysis and training, examples for coalition letter, SWB and DWR meetings, RWA comment letter, SacTree/UC Davis/ReLeaf
- CII: ACWA workgroup
- Water Loss: ACWA workgroup, CA NV AWWA Committee, coalition letters, WSO memo, DM memo, SWB meetings/staff, RWA Water Loss group

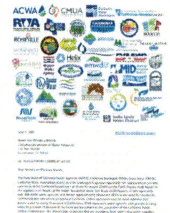

BE WATER SMART

## What is RWA doing to assist suppliers?

- Advocating for better standards for 5+ years with a technical feasibility approach
- Regional public outreach and school education program
- Turnkey efficiency rebate programs – add \$ and go
- Development of regional programs to meet requirements
  - CII Performance Measures
  - Currently piloting CII programs for scaling as needed later
- Research studies to run more efficient programs
- Program manager technical assistance
- Securing grant funding



BeWaterSmart.info

BE WATER SMART

## Next Steps

- SWB reviewing comments and incorporating changes
- Expect updated and final draft in late May/early June
- 15-day comment period
- July/August adoption
- Effective in fall 2024
- Annual reporting by January 1, 2025
- And we are still working on advocacy and improvements!
  - CWA Panel with David Mitchell, Ellen Hanak, and Chair Esquivel
  - PPIC op-ed
  - Tree irrigation factor



BeWaterSmart.info

Thank you!

Amy Talbot  
atalbot@rwah2o.org  
214.914.2510

## ARE YOU SUMMER STRONG?

Maurice is. He knows that native plants grow strong and deep roots that muscle through hot summers.

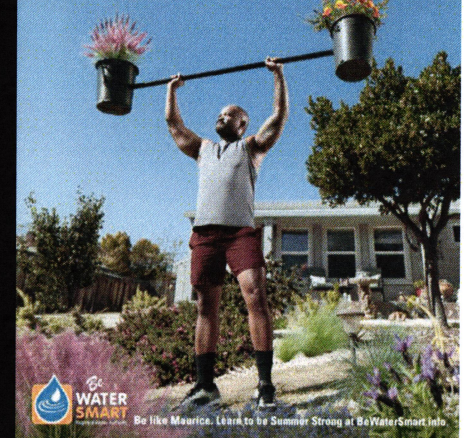



**May 20, 2024**

**Staff Report Briefing Materials**

**AGENDA ITEM VI.8**

**Discussion and possible action on additional funding for 2024 expenses**

---

**AGENDA ITEM VI.8**

REGULAR Board Meeting on May 20, 2024

---

To: Board of Directors  
From: Tom R. Gray  
Date: May 16, 2024  
Subject: Discussion and possible action on additional funding for 2024 expenses

---

**Recommendation:**

Authorize the General Manager to transfer \$325,000 from the reserves to cover 2024 expenses as detailed below.

**Discussion:**

***System Maintenance / Repair - Damages (E24SMDAM)***

Due to the ongoing damage repairs for the Transmission Main Break at the corner of Pershing Ave. and Chestnut Ave., costs will exceed the Board approved 2024 funding for System Maintenance / Repair – Damages of \$25,000.

Staff requests an additional \$325,000 from the reserves to cover the total anticipated capital project cost. FOWD staff will be seeking recovery through ACWA JPIA.

**Policy Implications:**

None.

**Fiscal Impact:**

This fund transfer will decrease the 2024 reserves by \$325,000.

Final financial impact has yet to be determined - with FOWD staff anticipating partial recovery of costs for surface restoration from insurance claims.

**May 20, 2024**

**Staff Report Briefing Materials**

**AGENDA ITEM VIII.2**

**Regional Water Authority (RWA)**



**REGIONAL WATER AUTHORITY  
MEETING OF THE BOARD OF DIRECTORS**

**Thursday, May 16, 2024 at 9:00 a.m.**

**The Sacramento Association of Realtors  
2003 Howe Avenue, Sacramento, CA 95825  
(916) 967-7692**

**IMPORTANT NOTICE REGARDING VIRTUAL PUBLIC PARTICIPATION:**

The Regional Water Authority currently provides in person as well as virtual public participation via the Zoom link below until further notice. The public shall have the opportunity to directly address the Board on any item of interest before or during the Board's consideration of that item. Public comment on items within the jurisdiction of the Board is welcomed, subject to reasonable time limitations for each speaker.

Join Zoom Meeting

<https://us06web.zoom.us/j/89073814270>

Meeting ID: 890 7381 4270

Dial by your location

+1 669 444 9171 US or +1 669 900 6833 US (San Jose)

**If we experience technical difficulties and the Zoom link drops and you are no longer able to connect to the Board meeting, please dial 1-877-654-0338 – Guest Code 198**

Public documents relating to any open session item listed on this agenda that are distributed to all or a majority of the members of the Board of Directors less than 72 hours before the meeting are available for public inspection in the customer service area of the Authority's Administrative Office at the address listed above.

In compliance with the Americans with Disabilities Act, if you have a disability and need a disability related modification or accommodation to participate in this meeting, please contact the Executive Director of the Authority at (916) 967-7692. Requests must be made as early as possible, and at least one full business day before the start of the meeting. The Board of Directors may consider any agenda item at any time during the meeting.

## AMENDED AGENDA

**1. CALL TO ORDER AND ROLL CALL**

**2. PUBLIC COMMENT:** Members of the public who wish to address the Board may do so at this time. Please keep your comments to less than three minutes.

**3. CONSENT CALENDAR:** All items listed under the Consent Calendar are considered and acted upon by one motion. Board Members may request an item be removed for separate consideration.

**3.1** Approve the draft meeting minutes of March 14, 2024, RWA Board Meeting

**Recommended Action: Approve Consent Calendar items as presented**

**4. FISCAL YEAR 2024-2025 BUDGET**

Presenter: Jim Peifer, Executive Director

**Recommended Action: Approve 2024-2025 Budget**

**5. REVISIONS TO POLICY 300.1 (AUTHORITY DELEGATED TO THE EXECUTIVE DIRECTOR AND POLICY 300.2 (PROFESSIONAL SERVICES POLICY)**

Presenter: Jim Peifer, Executive Director

**Discussion/Action: Approve Revisions to Policy 300.1 and Policy 300.2**

**6. WATERSHED RESILIENCE PILOT PROJECT**

Presenter: Trevor Joseph, Manager of Technical Services

**Action: Approve of the alternate selection process consistent with RWA Policy 300.2**

**7. INFORMATION: CONSERVATION REGULATIONS UPDATE**

Presenter: Amy Talbot, Water Use Efficiency Program Manager

**8. INFORMATION: SACRAMENTO REGIONAL WATER BANK UPDATE**

Presenter: Trevor Joseph, Manager of Technical Services

**9. EXECUTIVE DIRECTOR'S REPORT**

**10. DIRECTORS' COMMENTS**

**ADJOURNMENT**

**Next RWA Board of Director's Meeting:**

July 11, 2024, 9:00 a.m. at Carmichael Water District, 7837 Fair Oaks Blvd., Carmichael, CA 95608. The location is subject to change.

**Next RWA Executive Committee Meeting:**

May 28, 2024, 1:30 p.m. at the RWA Office, 2295 Gateway Oaks, Suite 100  
Sacramento, CA 95833.

Notification will be emailed when the RWA electronic packet is complete and posted on  
the RWA website at: <https://www.rwah2o.org/meetings/board-meetings/>.

Posted on May 13, 2024

*Ashley Flores*  
\_\_\_\_\_  
Ashley Flores, CMC  
Clerk of the Board

**May 20, 2024**

**Staff Report Briefing Materials**

**AGENDA ITEM VIII.4**

**Other**

SACRAMENTO REGIONAL  
**WATER BANK**

*A Sustainable Storage & Recovery Program*

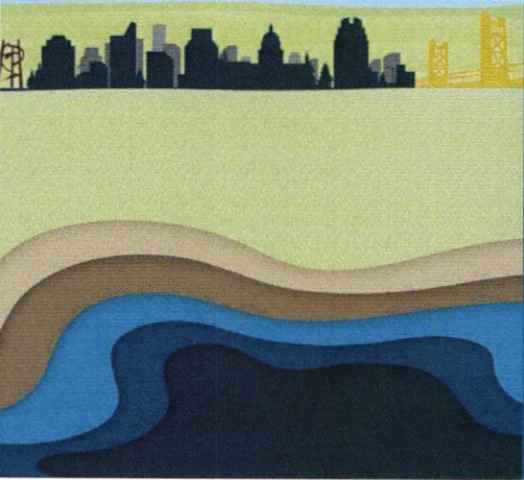

# Program Committee Meeting

May 15, 2024



Regional Water Authority  
PROVIDING SOLUTIONS TO NORTHWEST CALIFORNIA

## Today's Agenda

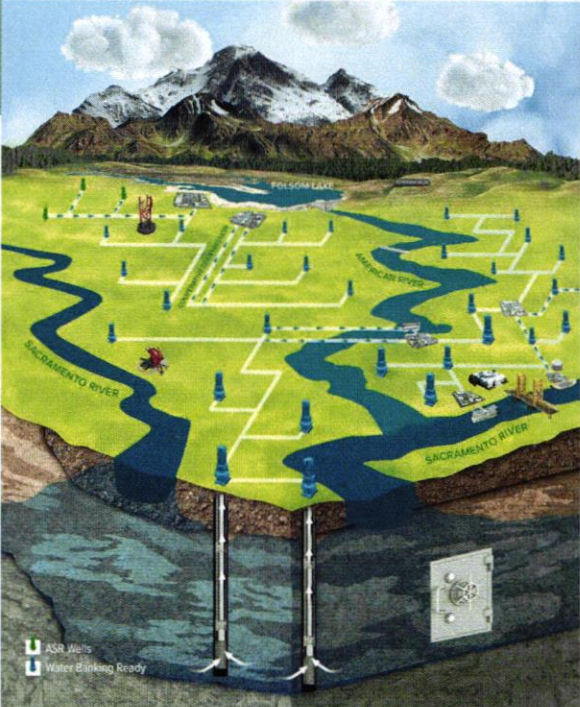

PROGRAM COMMITTEE MEETING—May 15, 2024

1. Today's Meeting
2. Program Committee Decisions—CEQA and WAS
3. Brainstorming/Information Gathering—Previously Banked Water
4. Budget Update
5. Recap, Action Items, and Next Steps



## Today's Agenda

PROGRAM COMMITTEE MEETING – May 15, 2024

1. Today's Meeting
2. Program Committee Decisions—  
CEQA and WAS
3. Brainstorming/Information  
Gathering—Previously Banked  
Water
4. Budget Update
5. Recap, Action Items, and Next  
Steps

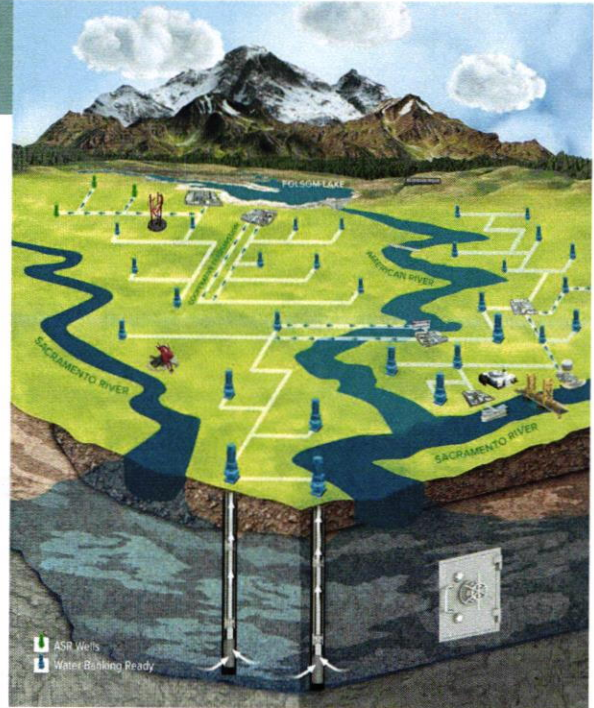

## Today's Agenda

PROGRAM COMMITTEE MEETING – May 15, 2024

1. Today's Meeting
2. Program Committee Decisions—  
**CEQA and WAS**
3. Brainstorming/Information  
Gathering—Previously Banked  
Water
4. Budget Update
5. Recap, Action Items, and Next  
Steps

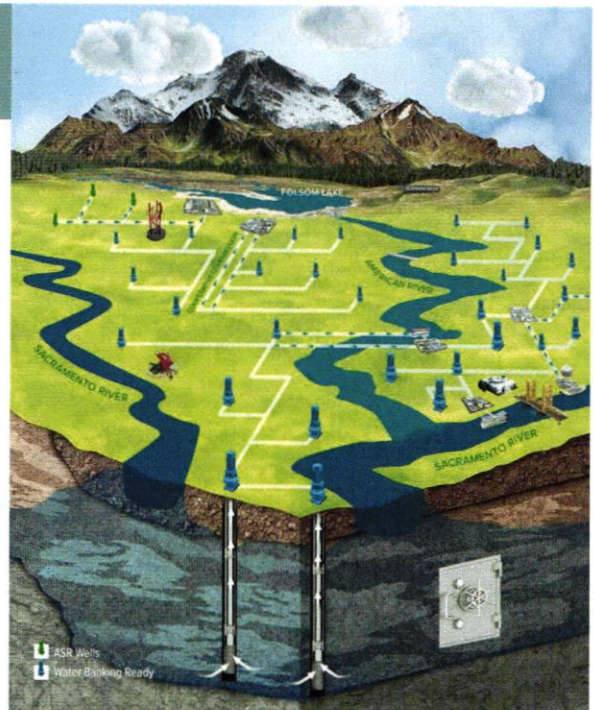

# Out-of-Basin Transfers

Decision #1



PROGRAM COMMITTEE MEETING—May 15, 2024

Under the proposed project for CEQA, the maximum annual recharge and recovery quantities would be still be 65 taf/yr and 55 taf/yr, respectively. (Those maximum amounts are based on 2024 discussions with Participating Agencies.)

Voluntary Agreement commitments would range from 0-20 taf/yr.

In years when no recovery actions would be taken to satisfy the VA, up to 55 taf/yr could be transferred out-of-basin (if all other conditions and requirements were met).

**Staff Recommendation: Include program-level analysis of out-of-basin transfers of up to 55 taf/yr. This also includes appropriate revisions to NOP and CEQA Project Description.**

## Leave Behind vs Losses

**Losses** – Portion of banked water that migrates out of the basin to water bodies (accretions to streams) or adjacent basins (subsurface flow).

Losses will be reviewed and revised if appropriate on a 5-year cycle in conjunction with updating GSPs.

**Losses Benefit:**

- Losses to streams/rivers results in accretions which lessens or eliminated stream depletion from Recovery

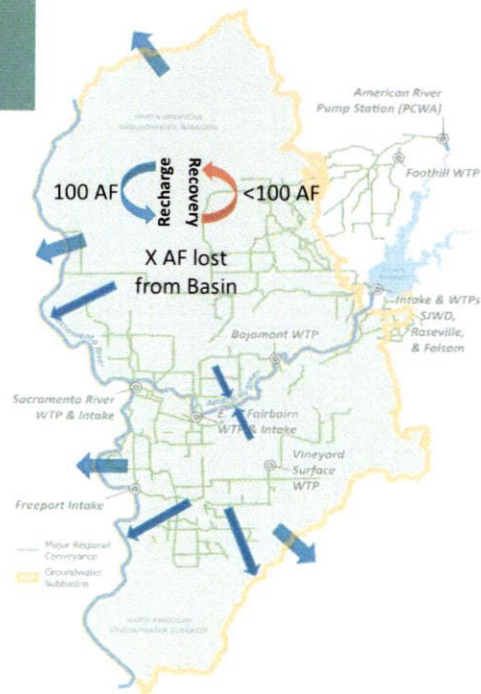

## Leave Behind vs Losses

**Leave Behind** - Designated portion of banked groundwater that is set aside to support groundwater basin sustainability and enhance local water supply reliability.

Leave behind volume is never to be recovered as part of water banking operations.

Subject to 5% (or to be informed by modeling analysis) at time of recharge

### Leave Behind Benefit:

- Bolsters groundwater in storage
- Percent can be increased by Participating Agency(ies) to augment local groundwater conditions
- Benefits all users of the groundwater basin

## Decision #2



## Water Bank WAS Scenario

	1
Scenario	Within Subbasin (NASb to NASb or SASb to SASb)
Source of Recharged Water	Local Agency Water
Recovered Water Beneficiary	Local Agency within same Subbasin
Leave behind	? %
Losses	Yes



## Water Bank WAS Scenario (cont.)

	1	2
<b>Scenario</b>	Within Subbasin (NASb to NASb or SASb to SASb)	Within Water Bank Area (NASb to SASb or SASb to NASb)
<b>Source of Recharged Water</b>	Local Agency Water	Local Agency Water
<b>Recovered Water Beneficiary</b>	Local Agency within same Subbasin	Local Agency in different Subbasin
<b>Leave behind</b>	? %	? %
<b>Losses</b>	Yes	Yes

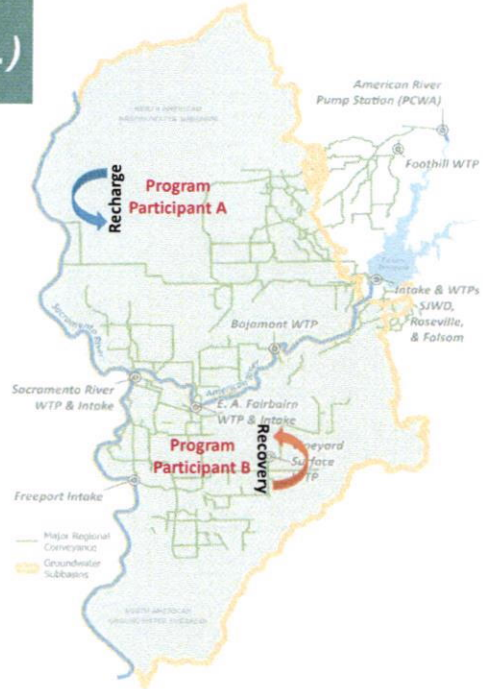

## Water Bank WAS Scenario (cont.)

	1	2	3a
<b>Scenario</b>	Within Subbasin (NASb to NASb or SASb to SASb)	Within Water Bank Area (NASb to SASb or SASb to NASb)	Outside of Water Bank Area
<b>Source of Recharged Water</b>	Local Agency Water	Local Agency Water	Local Agency Water
<b>Recovered Water Beneficiary</b>	Local Agency within same Subbasin	Local Agency in different Subbasin	External Party
<b>Leave behind</b>	? %	? %	? %
<b>Losses</b>	Yes	Yes	Yes

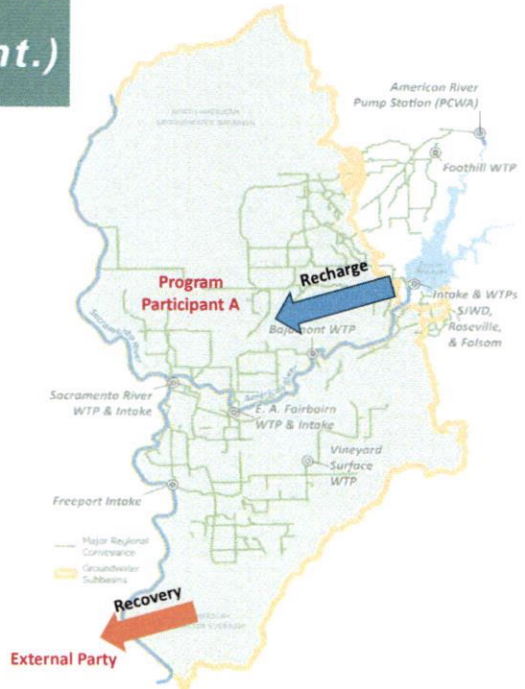

## Water Bank WAS Scenario (cont.)

	1	2	3a	3b
<b>Scenario</b>	Within Subbasin (NASb to NASb or SASb to SASb)	Within Water Bank Area (NASb to SASb or SASb to NASb)	Outside of Water Bank Area	
<b>Source of Recharged Water</b>	Local Agency Water	Local Agency Water	Local Agency Water	External Agency Water
<b>Recovered Water Beneficiary</b>	Local Agency within same Subbasin	Local Agency in different Subbasin	External Party	External Party
<b>Leave behind</b>	? %	? %	? %	5%
<b>Losses</b>	Yes	Yes	Yes	Yes

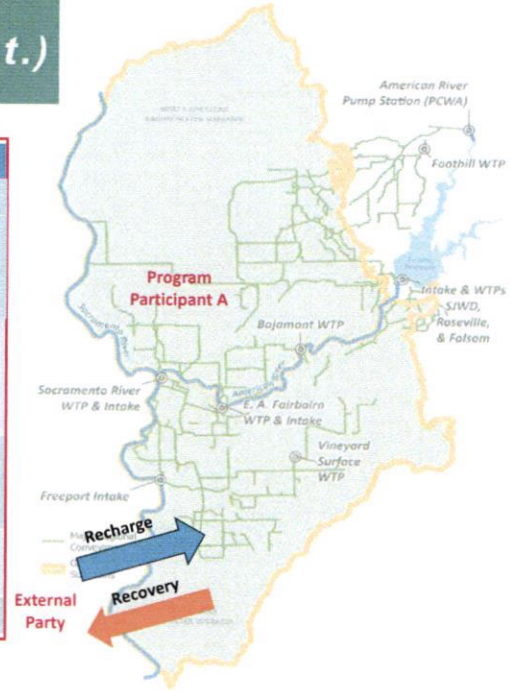

## Leave Behind

**Decision #2**



September 7, 2023, Program Committee Meeting Summary

Recommendation #4e: Recharge/Recovery – Leave Behind

Action/Decision: At a minimum, there will be a “leave behind” for out-of-basin water transfers. This leave behind will be no less than 5 percent.

No objections. Vote: passed by unanimous consent.

PROGRAM COMMITTEE MEETING—May 15, 2024

**Staff Recommendation: Include a leave-behind for all banked water for banked water made available for out of subbasin and external transfers and apply the leave-behind upfront. Percentage applied will be informed by WB analyses (to be conducted).**

PROGRAM COMMITTEE MEETING—May 15, 2024

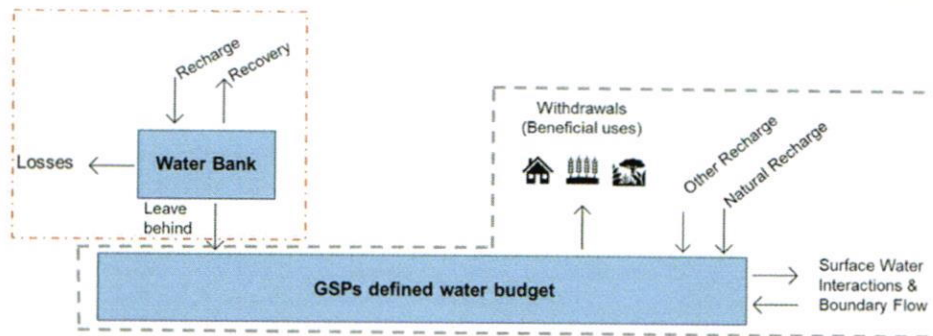

**Staff Recommendation:**

- **RWA coordinates with GSAs throughout the year on Water Bank operations and reports out annual totals to GSAs.**
- **GSAs do not approve Water Bank actions. However, the Water Bank Coordinating Body informs GSAs of water banking actions and provides annual summaries.**

## CEQA and WAS—What's Next?

PROGRAM COMMITTEE MEETING—May 15, 2024

- Re-issue NOP
- Initiate modeling of Water Bank baseline
- Continue to develop sections of EIR (e.g., existing setting)
- Continue to develop WAS

# SPLASH Alert

ACWA JPIA Risk Management and Member Services Departments



## CYBERSECURITY AND INFRASTRUCTURE SECURITY AGENCY (CISA)

**Alert and Advisory  
May 2024**

In May 2024, CISA released an important alert that water and wastewater agencies may find beneficial. In addition, the JPIA is sharing another relevant NSA and CISA Advisory.

The **JPIA's Risk Management Department** monitors and shares cyber security resources with our members to assist in keeping current with potential cyber threats of critical water and wastewater infrastructure.

Cyber Liability Insurance is an essential component of the JPIA's risk management strategy. In Fall 2023, the **JPIA's Member Services Department** announced the complementary cybersecurity services of [KYND](#) and [KnowBe4](#) for members participating in the JPIA's Cyber Liability Program. The implementation of KYND and KnowBe4 services will result in Member's reduced cyber vulnerabilities.

### NEW CISA ALERT

[Defending OT Operations Against Ongoing Pro-Russia Hactivist Activity](#) – May 1, 2024. CISA, in collaboration with U.S. and international partners, published this joint fact sheet that provides information and mitigations associated with cyber operations conducted by pro-Russia hactivists who seek to compromise industrial control systems (ICS) and small-scale operational technology (OT) systems in North American and European critical infrastructure sectors, including Water and Wastewater Systems, Dams, Energy, and Food and Agriculture Sectors.

### NSA AND CISA ADVISORY

[NSA and CISA Recommend Immediate Actions to Reduce Exposure Across all Operational Technologies and Control Systems](#) – October 2020. Internet-accessible operational technology (OT) assets are becoming more prevalent across the 16 U.S. CI sectors as companies increase remote operations and monitoring, accommodate a decentralized workforce, and expand outsourcing of key skill areas such as instrumentation and control, OT asset management/maintenance, and in some cases, process operations and maintenance. The National Security Agency (NSA) along with the Cybersecurity and Infrastructure Security Agency (CISA) recommend that all DoD, NSS, DIB, and U.S. critical infrastructure facilities take immediate actions to secure their OT assets.

[Click here](#) for a PDF version of this report.

### ADDITIONAL RESOURCES

[Subscribe to CISA Updates](#) webpage.

[CISA Resources and Tools](#) webpage.

[JPIA Risk Control Manual Water/Wastewater Security](#) webpage (see Section 26).

[JPIA Member Services Cybersecurity Resources](#) webpage.

[JPIA Five: Expanding Cyber Resilience with KnowBe4 and KYND](#) podcast.

**May 20, 2024**

**Staff Report Briefing Materials**

**AGENDA ITEM X.1**

**Maintenance Work Report**



# FAIR OAKS WATER DISTRICT

## GENERAL MANAGER'S REPORT TO BOARD OF DIRECTORS MAY 20, 2024 REGULAR MEETING

SUBJECT: 2024 METERED WATER ANALYSIS  
 STATUS: Information Item  
 REPORT AS OF: April 30, 2024

Parcel Count - by water service connection status				
Connected	Shared Meter Residential	Shared Meter Offices Commercial	Not Yet Connected Vacant	Total
13,689	474	72	356	14,591

Service Count - by service type					
	Active	Disconnected		Total	
		Maintenance	Collection	No Meter	Meter
Single Family	12,832	146	15	0	12,993
Multi Family	620	3	0	0	623
Commercial	293	11	1	0	305
Industrial	0	0	0	0	0
Institutional	90	9	0	2	97
Irrigation	222	32	5	0	259
Fire	99	2	0	101	0
			Subtotal	103	14,277
<b>Total</b>	<b>14,156</b>	<b>203</b>	<b>21</b>		<b>14,380</b>

Service Count - by meter size										
	1"	1.5"	2"	3"	4"	6"	8"	10"	Total	
Metered	13,324	604	303	11	19	9	4	3	14,277	
Not Metered	2	0	1	0	35	41	23	1	103	

2024 Water Supply - units of production: acre-feet (AF)													
	Jan	Feb	Mar	Apr	May	Jun	Jul	Aug	Sep	Oct	Nov	Dec	Total
SW	237.54	291.39	368.35	485.21									1,382.49
GW	109.87	31.73	30.87	39.83									212.30
CWD	0.00	0.00	0.00	0.00									0.00
<b>Total</b>	<b>347.41</b>	<b>323.12</b>	<b>399.22</b>	<b>525.04</b>	0.00	0.00	0.00	0.00	0.00	0.00	0.00	0.00	1,594.79

Groundwater Supply - percentage (%)													
	Jan	Feb	Mar	Apr	May	Jun	Jul	Aug	Sep	Oct	Nov	Dec	Total
2024	32%	10%	8%	8%									13%

Drought Reduction By Volume - acre-feet (AF)													
	Jan	Feb	Mar	Apr	May	Jun	Jul	Aug	Sep	Oct	Nov	Dec	Total
2024	347.41	323.12	399.22	525.04									1,594.79
2013	401.21	428.28	661.68	839.24									2,330.41
%	13.41	24.55	39.67	37.44									31.57

Residential Water Use - residential gallons per-capita per day (R-GCPD) <sup>1</sup>													
	Jan	Feb	Mar	Apr	May	Jun	Jul	Aug	Sep	Oct	Nov	Dec	Average
2024	76	75	87	118									89

<sup>1</sup> Based on population of 36,226 and 75% of Water Supply used for Residential



# Monthly Maintenance Work Report

Date	Address	Type
<b>AMR Replacements</b>	<b>Monthly Total</b>	<b>41</b>
		<b>AMR / R900i #</b>
4/5/2024	7983 GLENBAR WAY	1576354792
4/5/2024	5701 SKYRIDGE DR	1574611570
4/5/2024	8021 HIDDEN VIEW CIR	1576354560
4/8/2024	4848 AIRBORNE WAY	1576354802
4/8/2024	9050 WINDING OAK DR	1576336932
4/15/2024	8742 LAKE NIMBUS DR	1576354630
4/15/2024	8800 TRIPLE CROWN CT	1576348042
4/15/2024	4205 THISTLEDOWN DR	1576343568
4/16/2024	9160 MADISON AVE	1578985882
4/16/2024	8736 BLUFF LN	1576349616
4/16/2024	9083 APPROACH CT	1576340386
4/16/2024	4925 KITTY HAWK ST	1576359958
4/16/2024	9178 MADISON GREENS LN	1576343580
4/16/2024	9112 MADISON GREENS LN	1576354632
4/16/2024	5419 YDRA CT	1576361560
4/16/2024	4814 SUNSET PLACE LN	1578982832
4/18/2024	9251 WINDING OAK DR	1579252952
4/18/2024	5160 LONG CANYON DR	1577286256
4/18/2024	8513 HAYDEN WAY	1579250190
4/18/2024	9317 WINDING OAK DR	1574426782
4/18/2024	9104 WESTCLIFF LN	1579586320
4/19/2024	9363 BLUE OAK DR	1578976144
4/19/2024	9160 MADISON AVE	1576349612
4/19/2024	9472 TWIN LAKES AVE	1579250196
4/19/2024	5118 DREDGER WAY	1576354786
4/19/2024	8839 BLUFF LN	1576328990
4/22/2024	5737 ALMOND AVE	1576241182
4/23/2024	4520 DIETZ WAY	1576484526
4/23/2024	8407 BUFFUM CT	1577321096
4/23/2024	8135 WINDING WAY	1577328244
4/23/2024	4801 POLO CT	1576472046

Date	Address	Type
4/25/2024	5340 MAUI WAY	1579255008
4/25/2024	5220 OAKRIDGE CT	1579254864
4/25/2024	9292 MADISON AVE	1577300366
4/25/2024	4914 FORRESTAL ST	1577334172
4/25/2024	9000 LEATHAM AVE	1579255510
4/25/2024	5031 LUKE WAY	1579255012
4/25/2024	8237 SMITH FARM CT	1579252768
4/25/2024	9035 LA SERENA DR	1578822044
4/25/2024	4525 WAWONA CIR	1579252742
4/25/2024	8918 LA SERENA DR	1579250240

1" Meter Install	Monthly Total	1	Meter #
4/8/2024	9166 MADISON GREENS LN		16411274

Leaks	Monthly Total	8	DETAIL
4/1/2024	3848 RIVA RIDGE		SERVICE LEAK
4/3/2024	8856 TIMM AVE		SERVICE LEAK
4/3/2024	5426 YDRA CT		SERVICE LEAK
4/10/2024	9152 KENDRICK WAY		SERVICE LEAK
4/20/2024	4237 CURRAGH OAKS LN		MAIN LEAK
4/22/2024	8400 RANCHITA WAY		MAIN LEAK
4/24/2024	5801 CHESTNUT AVE		TRANSMISSION MAIN LEAK
4/26/2024	5542 BEAUREGARD WAY		SERVICE LEAK

Distribution Repairs	Monthly Total	2	DETAIL
4/2/2024	3848 RIVA RIDGE		1" SERVICE REPAIR
4/22/2024	8400 RANCHITA WAY		6" MAIN REPAIR

System Upgrades	Monthly Total	9	DETAIL
4/3/2024	7236 FALCON RD		HYDRANT UPGRADE
4/8/2024	4904 DOVE DR		HYDRANT UPGRADE
4/10/2024	8856 TIMM AVE		1" SVC UPGRADE
4/10/2024	8862 TIMM AVE		1" SVC UPGRADE
4/11/2024	5426 YDRA CT		1" SVC UPGRADE
4/11/2024	5422 YDRA CT		1" SVC UPGRADE
4/15/2024	9152 KENDRICK WAY		1" SVC UPGRADE
4/23/2024	7715 OAK LEAF WAY		HYDRANT UPGRADE
4/29/2024	4830 HARTMAN WAY		HYDRANT UPGRADE



**May 20, 2024**

**Staff Report Briefing Materials**

**AGENDA ITEM X.2**

**Capital Projects Status Report**

**FAIR OAKS WATER DISTRICT**  
**CAPITAL PROJECTS STATUS UPDATE: April 30, 2024**

Project Description	2024 Year-to-Date								Total Project					Project Status Comments
	2024 Approved Budget	Budget Transfers	2023 C/F**	Adjusted Budget Amount	Year-to-Date-Expenses	Remaining Funds	YTD Percent \$ Expended	Percent Completed	Total Budget/Fund to Date	Total Expenses to Date	Total Project Remaining Fund	Total Project Percent \$ Expended	Prior Years Expenses (WIP Projects)	
1 New York Well Design (C24WTNYWD)	\$ -	\$ -	\$ 23,404	\$ 23,404	\$ -	\$ 23,404	0%	96%	\$ 365,546	\$ 342,142	\$ 23,404	94%	\$ 342,142	Plans and specifications are being revised prior to bidding the project.
2 New York Well Drilling & Equipment (C24WTNYWDE)	2,940,000	-	-	2,940,000	6,235.30	2,933,765	0%	50%	3,855,744	921,979	2,933,765	24%	915,744	Reviews of the submittals from Trillium for the order for the pump, motor and 3R aquifer storage and recovery valve are now complete. FOWD may expect an invoice for a 20% downpayment for production soon.
3 Skyway Drilling & Equipment (C24WTSDE)	-	-	341,966	341,966	99,962.69	242,004	29%	85%	2,762,903	2,520,899	242,004	91%	2,420,936	The project is complete. Work left to be done involves paperwork for the grant.
4 Northridge Well Replacement - Design (C24WTNWRD)	450,000	-	-	450,000	696.67	449,303	0%	0%	450,000	697	449,303	0%	-	A request for proposal for engineering services has been distributed and posted on 4/1/24.
5 Northridge Well Replacement - Equipping (C24WTNWRE)	1,450,000	-	-	1,450,000	-	1,450,000	0%	0%	1,450,000	-	1,450,000	0%	-	
6 Gum Ranch Tank Site (C24WTGRTS)	214,000	-	56,335	270,335	471.01	269,864	0%	14%	317,700	47,836	269,864	15%	47,365	
<b>Subtotal Wells &amp; Tanks</b>	<b>\$ 5,054,000</b>	<b>\$ -</b>	<b>\$ 421,705</b>	<b>\$ 5,475,705</b>	<b>\$ 107,365.67</b>	<b>\$ 5,368,339</b>			<b>\$ 9,201,892</b>	<b>\$ 3,833,553</b>	<b>\$ 5,368,339</b>		<b>\$ 3,726,187</b>	
7 Hydrant Upgrades (C24TDHU)	\$ 250,000	\$ -	\$ 3,200	\$ 253,200	\$ 110,493.60	\$ 142,706	44%	50%	\$ 253,200	\$ 110,494	\$ 142,706	44%	\$ -	
8 New Hydrants (C24TDNH)	80,000	-	-	80,000	-	80,000	0%	0%	80,000	-	80,000	0%	-	
9 Minor Main Upgrades (C24TDMU)	75,000	-	-	75,000	8,366.38	66,634	11%	6%	75,000	8,366	66,634	11%	-	
10 Services Upgrade (C24TDSU)	538,200	-	-	538,200	184,229.95	353,970	34%	35%	538,200	184,230	353,970	34%	-	
11 Developer's Paid - Service Installation and Main Line Projects*	59,100	-	112,558	171,658	15,388.06	156,270	9%	7%	171,658	85,032	86,626	50%	69,644	
12 Replacement of Four Distribution Sampling Stations (C24TDSS)	20,000	-	-	20,000	2,235.23	17,765	11%	0%	20,000	2,235	17,765	11%	-	
<b>Subtotal</b>	<b>\$ 1,022,300</b>	<b>\$ -</b>	<b>\$ 115,758</b>	<b>\$ 1,138,058</b>	<b>\$ 320,713.22</b>	<b>\$ 817,345</b>			<b>\$ 1,138,058</b>	<b>\$ 390,357</b>	<b>\$ 747,701</b>		<b>\$ 69,644</b>	
13 Hazel Ave. Widening Project Phase III (C24TD255)	\$ -	\$ -	\$ 1,976	\$ 1,976	\$ -	\$ 1,976	0%	100%	\$ 1,481,632	\$ 1,479,656	\$ 1,976	100%	\$ 1,479,656	Complete.
14 ARV's and Blow-offs (C24TDARV)	50,000	-	-	50,000	2,181.79	47,818	4%	4%	50,000	2,182	47,818	4%	-	
15 Replace 12" Steel Main New York Ave. (C24TDNYASW)	2,132,000	-	-	2,132,000	885.33	2,131,115	0%	5%	2,376,800	245,685	2,131,115	10%	244,800	Bid specification and plans for Phase I are ready to be put out for bid. 12-inch pipe for the project has been purchased and is available for use.
16 T-Main Replacement Phase I (Skyway Dr. to Hazel) (C24TD5H)	145,000	-	-	145,000	92.35	144,908	0%	0%	145,000	92	144,908	0%	-	
17 County Overlay Project- Madison, Kenneth to McKay (C24TDHAKM)	100,000	-	-	100,000	-	100,000	0%	0%	100,000	-	100,000	0%	-	Sacramento County DOT reported this portion of their project is being moved to the spring of 2026.
18 Greenvale Improvements (C24TDGI)	55,000	-	-	55,000	-	55,000	0%	0%	55,000	-	55,000	0%	-	
19 Riverfront Lane Service Upgrade (C24TDRFL)	90,900	-	-	90,900	1,056.66	89,843	1%	8%	100,001	10,157	89,843	10%	9,101	Easements and exhibits have been drafted for review and resident's signatures. Staff reviewing options for main replacement.
<b>Subtotal</b>	<b>\$ 2,572,900</b>	<b>\$ -</b>	<b>\$ 1,976</b>	<b>\$ 2,574,876</b>	<b>\$ 4,216</b>	<b>\$ 2,570,660</b>			<b>\$ 4,308,433</b>	<b>\$ 1,737,773</b>	<b>\$ 2,570,660</b>		<b>\$ 1,733,557</b>	
<b>TOTAL CAPITAL IMPROVEMENT PROGRAM</b>	<b>\$ 8,649,200</b>	<b>\$ -</b>	<b>\$ 539,439</b>	<b>\$ 9,188,639</b>	<b>\$ 432,295.02</b>	<b>\$ 8,756,344</b>			<b>\$ 14,648,383</b>	<b>\$ 5,961,683</b>	<b>\$ 8,686,700</b>		<b>\$ 5,529,388</b>	
20 AMR Replacement (M24MMAMR)	\$ 250,000	\$ -	\$ 39,650	\$ 289,650	\$ 58,691.77	\$ 230,958	20%	20%	\$ 289,650	\$ 58,692	\$ 230,958	20%	-	On-going.
21 Large Meter Replacement (M24MMLMR)	25,000	-	-	25,000	-	25,000	0%	0%	25,000	-	25,000	0%	-	
22 Meter Replacement (M24MMMR)	140,000	-	28,959	168,959	34,163.11	134,796	20%	20%	168,959	34,163	134,796	20%	-	On-going.
23 Meter Installation - Residential (M24MMMRRES)	5,000	-	-	5,000	181.72	4,818	4%	4%	5,000	182	4,818	4%	-	On-going.
<b>METER MAINTENANCE PROGRAM</b>	<b>\$ 420,000</b>	<b>\$ -</b>	<b>\$ 68,609</b>	<b>\$ 488,609</b>	<b>\$ 93,036.60</b>	<b>\$ 395,572</b>			<b>\$ 488,609</b>	<b>\$ 93,037</b>	<b>\$ 395,572</b>		<b>\$ -</b>	
24 10317 Corporate Yard Project (A24BUMQDC)	\$ 200,000	\$ -	\$ -	\$ 200,000	\$ 85,740.13	\$ 114,260	43%	35%	\$ 394,500	\$ 280,240	\$ 114,260	71%	\$ 194,500	G/A has submitted plans to Sacramento County. FOWD is paying County review fees as they are being received. No feedback has been received from the County yet.
25 10326 Admin. Building (A24BUNB)	\$ 5,000	\$ -	\$ -	\$ 5,000	\$ -	\$ 5,000	0%	0%	\$ 5,000	\$ -	\$ 5,000	0%	-	
<b>GRAND TOTAL</b>	<b>\$ 9,274,200</b>	<b>\$ -</b>	<b>\$ 608,048</b>	<b>\$ 9,882,248</b>	<b>\$ 611,071.75</b>	<b>\$ 9,271,176</b>			<b>\$ 15,536,491</b>	<b>\$ 6,334,959</b>	<b>\$ 9,201,532</b>		<b>\$ 5,723,888</b>	

\*New Business development pays for services rendered (this item is a pass through).  
 \*\*2023 Carryforward funding approved by the Board on January 16, 2024 and March 18, 2024 Regular Board Meetings.  
 \*\*\*New York Well 12-inch Replacement Project includes both North and South of Main.

**May 20, 2024**

**Staff Report Briefing Materials**

**AGENDA ITEM X.3**

**Authorizations of Additional Funding**



**GENERAL MANAGER'S REPORT**  
**May 20, 2024 REGULAR BOARD MEETING**  
*Report as of April 30, 2024*

**X.3 Authorizations of Additional Funding**

Accounting for 2024 Contingency Fund  
 Project No. E24CONT

<u>Date</u>	<u>Description</u>	<u>Beginning Balance</u>	<u>Amount Transferred</u>	<u>Ending Balance</u>
1/1/2024	Beginning Balance	\$ 200,000.00	\$ -	\$ 200,000.00
1/16/2024	SWRCB - Water System Fees	200,000.00	(500.00)	199,500.00
1/16/2024	Deferred Compensation	199,500.00	(4,250.00)	195,250.00
3/18/2024	Hazel Avenue Project #2004	195,250.00	(29,616.00)	165,634.00
3/18/2024	Gum Ranch Unit 2 Project #1607	165,634.00	(41,969.00)	123,665.00
<b>Total from Contingency</b>			<b>\$ (76,335.00)</b>	

**Funds Drawn from Reserves**

<b>Total from Reserves</b>	<b>\$ -</b>
<b>Total Authorizations of Additional Funding</b>	<b>\$ 76,335.00</b>



---

**May 20, 2024**

**Staff Report Briefing Materials**

**AGENDA ITEM X.5**

**Claims Against District**



# FAIR OAKS WATER DISTRICT

## GENERAL MANAGER'S REPORT TO BOARD OF DIRECTORS MAY 20, 2024 REGULAR MEETING

SUBJECT: Processing of Claims  
STATUS: Information Item  
REPORT AS OF: April 30, 2024

### DISTRICT CLAIMS RECEIVED

Claim #	Date Claim Received	Type of Claim	Claim Amount	JPIA Contacted ?	Claim Status	Settlement Amount
<b>No Open Claims</b>						